



# YELLOW JACKET®

## HVAC/R SERVICE TOOLS

YELLOWJACKET.COM

EDITION 70



 MADE IN THE USA



1949 - 2019



Anniversary



## For over 70 years, the YELLOW JACKET® name has been synonymous with quality products and service in the HVAC/R industry.

It all started back in 1946, when the late Jack Ritchie founded Ritchie Engineering Company in Minneapolis, Minnesota as a fabrication/manufacture's representative organization. Jack worked hard and in 1949 he created a high-quality charging hose. Jack picked yellow for the color of the hose – which later became the industry standard for refrigerant. The color stuck with Jack and inspired the name YELLOW JACKET®. Today, that hose is known as the YELLOW JACKET® Charging Hose and remains the best-selling refrigeration recovery hose in the industry for almost 70 years.

“While a lot has changed in the last 70 years, but one thing has remained the same...our philosophy of providing HVAC/R professionals the quality products they need, at a competitive price, with fast delivery and dependable follow-up,” said Tom Ritchie, President and CEO.

Since the launch of its first charging hose, YELLOW JACKET® has continued to innovate and expand its line of recovery and service tools. While the brand has sold hundreds of thousands of its namesake hose, YELLOW JACKET® has set the bar within the HVAC/R industry with innovative digital manifolds, tubing tools, vacuum pumps, leak detectors, recovery units, electronic instruments and a line of automotive recovery products.

YELLOW JACKET® remains dedicated to its philosophy of creating quality products which are made with exacting standards. Products are carefully assembled by highly-skilled workers at our manufacturing facility, who do everything from producing the smallest coupler to bagging the final packaging. Every shipment is double-checked by weight before shipping out the door.

From its humble beginnings, the YELLOW JACKET® brand has continued to grow and innovate while still a family business, owned and operated by Tom & Kristen Ritchie. YELLOW JACKET® products are now available worldwide.

As we look towards the future, we recognize the need for sustainable solutions to a myriad of challenges. When it comes to product development, packaging, shipping and manufacturing, we are committed to evaluate all options towards the goal of smaller environmental impact while maintaining our innovative edge.







**Charging Systems & Diagnostic Tools ..... Page 5-26**

P51 TITAN® Digital Manifold ..... 7-8  
 YJACK™ Wireless BLE HVAC Sensors ..... 9-12  
 MANTOOTH® Wireless Digital Pressure/Temperature/Vacuum Gauge ..... 13-14  
 TITAN® Manifolds ..... 15, 17-18  
 CO<sub>2</sub> Test and Charging Manifold ..... 16, 19  
 BRUTE II® Manifolds ..... 20-21  
 Series 41 Manifolds ..... 21-23  
 Ammonia Manifold ..... 23  
 Series 41 Digital Manifold ..... 24  
 Heat Pump Manifold ..... 25  
 Manifold Parts Kit ..... 26  
 Single Gauge Manifolds and Test Gauges ..... 26



**Specialized and General Use Gauges ..... Page 27-32**

3-1/8" Manifold Gauges ..... 29  
 3-1/2" Liquid-filled Manifold Gauges ..... 30  
 2-1/2" Manifold Gauges ..... 30  
 Digital Manifold Gauge ..... 31  
 Brass Manifold Gauges ..... 31  
 Protective Gauge Boots ..... 31  
 Ammonia, Mechanical and Diaphragm Gauges ..... 32



**Refrigerant Recovery Systems ..... Page 33-38**

Refrigerant Recovery Machines ..... 35-36  
 Recovery Machine Comparison Chart ..... 37  
 Refrigerant Recovery Machine Accessories and Parts ..... 38  
 Wrap-around Heater for Refrigerant Cylinder and The Trap Separator ..... 38



**Vacuum Pump Systems ..... Page 39-48**

SUPEREVAC™ Vacuum Pumps ..... 41  
 BULLET® Vacuum Pumps ..... 42  
 YJII® Vacuum Pumps ..... 43  
 MAXFLOW™ Evacuation Kits ..... 43  
 Ammonia and Belt Drive Pumps ..... 44  
 Vacuum Pump Oil and Exhaust Filter ..... 44  
 SUPEREVAC™ Evacuation Manifolds and Systems ..... 45, 47  
 Omni Vacuum Gauge ..... 46  
 Vacuum Gauge Cleaning Kit ..... 46  
 Digital Vacuum Gauges ..... 47-48  
 Vacuum Pump Adapters and Heat Gun ..... 48  
 Mechanical Vacuum Gauges ..... 48



**Vacuum and Charging Hoses ..... Page 49-61**

The Anatomy of a Hose ..... 51  
 1/4" PLUS II™ Charging Hoses ..... 52-53  
 9" FlexFlow™ Adapter Hoses ..... 53  
 3/8" PLUS II™ "B" Charging Hose ..... 54  
 PLUS II™ Heavy Duty Charging Hoses ..... 54-56  
 Automotive and Special 1/4" Chargings ..... 56  
 Hose Comparison Chart ..... 57  
 Ammonia, Fuel Oil, Oil Pump and Cylinder Valve Hoses ..... 58  
 High Pressure Control Hoses ..... 59  
 Metal Hoses ..... 60  
 CO<sub>2</sub> Test and Charging Manifold ..... 61



**Hose Adapters, Valves and Parts ..... Page 62-67**

Ball Valves and Valve Tool ..... 63  
 Valves, Filters, Adapters and Couplers ..... 64  
 Quick Couplers ..... 65  
 Single Valves, Hose Replacement Parts and Gasket Remover Pick ..... 66  
 Automotive Fittings and Adapters ..... 67

Continued

CHARGING SYSTEMS  
GAUGES  
RECOVERY MACHINES  
VACUUM PUMP SYSTEMS  
VACUUM AND CHARGING HOSES  
HOSE ADAPTERS, VALVES & PARTS  
WIRELESS AND ELECTRONIC INSTRUMENTS  
LEAK DETECTORS AND MONITORS  
HEATING INSTRUMENTS  
SYSTEM TOOLS



**Wireless and Electronic Instruments ..... Page 68-79**

YJACK™ Wireless BLE HVAC Sensors ..... (9-12) 70  
 Wireless BLE Refrigerant Charging Scale.....70  
 Electronic Refrigerant Charging Scales ..... 71-72  
 MANTTOOTH® Wireless Digital Pressure/Temperature/Vacuum Gauges ..... 73-74  
 Omni Vacuum Gauge .....75  
 Digital Vacuum Gauges..... 76-77  
 SUPEREVAC™ LCD Vacuum Gauge .....77  
 Refrigerant Analyzer.....78  
 Thermometers ..... 78-79  
 Anemometers.....79

**Leak Detectors and Leak Monitors ..... Page 80-87**

AccuProbe™ Leak Detectors..... 82-83  
 H<sub>2</sub> Detector and Micro UV Leak Detector Kits.....84  
 System Injectors.....85  
 Fluorescent Scanner Solutions..... 86-87  
 Cleaners .....87  
 Combustible Gas Detector .....87

**Heating Instruments..... Page 88-90**

Superheat Calculation Kit, Psychrometers and Manometers .....88  
 Digital Psychrometer..... 89  
 Fuel Oil Test Kit.....89  
 Adapter Cords.....89  
 Oil Pump Vibration Eliminator.....89  
 Gas Pressure Test Kit .....90  
 Test Gauges .....90

**System Tools ..... Page 91-108**

Flaring Tools ..... 93-95  
 Swaging and Expanding Tools.....96  
 Benders.....97  
 Digital Adjustable Torque Wrench.....98  
 Solenoid Valve Service Magnet .....99  
 Mini-split Toolkit and Torque Wrenches .....100  
 Service Wrenches.....101  
 Reaming and Deburring Tools.....102  
 Cutters ..... 102-103  
 Cutter Parts and Kits .....104  
 Hex Keys and Hex Key Wrenches.....105  
 Retaining Ring Pliers.....105  
 Refrigerant Recovery Pliers.....106  
 Fan Blade Puller .....106  
 Pinch-off Tools.....106  
 MaxFlow Oil Pumps.....107  
 Oil Pumps and Injectors.....107  
 Fin Combs and Straighteners .....108  
 Inspection Mirrors.....108  
 Safety Goggles.....108

**Product Index ..... Page 109-110**

**Manufacturers Representatives Map ..... Page 111**



# CHARGING SYSTEMS & DIAGNOSTIC TOOLS







## YJACK™ SERIES

YJACK™ Series sensors work together to provide a total HVAC/R diagnostics solution with wireless convenience. Coupled with the P51 TITAN® Digital Manifold, the user has all the necessary information for complete system diagnostics.



## P51 TITAN® DIGITAL MANIFOLDS



***Accurate measurements, analysis and reporting in your hands, and Bluetooth® capability to put them at your fingertips.***

The YELLOW JACKET® P51 TITAN® Digital Manifold Series provides ultimate system measurements with ease. This 4-valve manifold provides fast and accurate measurements for refrigeration and a/c systems. Measurements are displayed on a backlit digital display and can be transmitted via Bluetooth® to a Smartphone for even further analysis. Local display of system pressures and temperatures, superheat and subcool provide instant analysis. When connected to your Smartphone, target superheat and subcool are easily attained, along with all other capabilities of the YJACK VIEW™ or the ManTooth® app.

The flagship YELLOW JACKET® P51-870 TITAN® features a 4.3" full color touchscreen graphic display with digital and graphical representation of pressure and temperature measurements. It also features on-board data logging and standard vacuum sensor and measurements (vacuum sensor included). A 4-pack of hoses is included as well as two temperature clamps and a backpack carrying case for safe storage.

### P51-870 TITAN® ADDITIONAL FEATURES AND BENEFITS

- 4.3" full color touch screen display
- Digital and graphical representation of pressure and temperature measurements
- Vacuum sensor included
- Set of four manifold hoses included: (3) 1/4" RYB and (1) 3/8" yellow vacuum hose
- (2) temperature clamps included
- Backpack carrying case included
- Wirelessly measure and display relative humidity, dry bulb, wet bulb and dew point temperature alongside system pressure and temperature measurements (requires separate purchase of YJACK DEW™ PN 67063)



### P51 TITAN® SERIES FEATURES & BENEFITS

- Measures high and low side pressures and temperatures
- Displays vapor and liquid saturation temperatures
- System superheat and subcooling calculations
- On board data logging; export to your computer via USB
- YJACK VIEW™ app used with 40870, 40875 and 40877; ManTooth® app used with 40860
- Bluetooth® capability
- Pressure hold mode displays rate of change for both vacuum and positive pressure measurements
- 4-way TITAN® valve block
- 126 refrigerant profiles stored in the instrument including new blends not currently in the REFPROP database
- Backlit display with auto-dimming
- Auto shut-off
- Includes two temperature clamps
- Optional vacuum sensor available (included with P51-870)
  - Vacuum measurements, targets and leak testing
  - High and low alarm
- Re-chargeable battery with battery life indicator
  - Continuous use no backlight: 80 hours
  - Continuous use full backlight: 5 hours (40860) 4 hours (40870)
- US and International units (bar, psia, psig, kPa, MPa, kg/cm<sup>2</sup>)
- Maximum working pressure 700 psia (48.3 bar)
- USB charging port
- IP52 certified
- Robust housing
- Two-year warranty
- Made in the USA 





40870

**40870 INCLUDES:**

- Vacuum sensor (P/N 67030)
- Set of four manifold hoses: (3) 60", 1/4" RYB (P/N 21985) and (1) 60", 3/8" yellow vacuum hose 3/8" straight x 3/8" 45° (P/N 18160)
- (2) temperature clamps (P/N 67010)
- USB charging cable
- Backpack carrying case (P/N 10146)



40875

**40875 INCLUDES:**

- Vacuum sensor (P/N 67030)
- Set of (6) 60" manifold hoses: (3) RYB compact ball valves (P/N 29985); (1) Y 3/8" str x 3/8" 45° (P/N 18160); (2) compact ball valve 1/4" x 5/16" (P/N 29425 and 29465)
- (2) temperature clamps (P/N 67010)
- USB charging cable
- Backpack carrying case (P/N 10146)



40877

**40877 INCLUDES:**

- Vacuum sensor (P/N 67030)
- Set of (6) 60" manifold hoses: (3) RYB compact ball valves (P/N 29985); (1) Y 3/8" str x 3/8" 45° (P/N 18160); (2) compact ball valve 1/4" x 5/16" (P/N 29425 and 29465)
- (2) YJACK™ temperature clamps (67061)
- USB charging cable
- Backpack carrying case (P/N 10146)

**YJACK VIEW™ APP FEATURES**

- All the great features of the ManTooth® app
- Measure HVAC/R system pressure, temperature, saturation temperature, superheat and subcooling
- Monitor system evacuation status
- Check indoor air comfort and system efficiency with psychrometric air calculations: Percent relative humidity, dry bulb, wet bulb and dew point temperature measurements
- Monitor status of all nearby YJACK™ and P51-870 TITAN® devices
- Customize data view for each measurement
- Freely switch between multiple simultaneous sessions without loss of data
- Create highly customized datalogs which can be saved or emailed from your smart device
- Choose from 126 refrigerant profiles found in the REFPROP database
- Available on iOS (version 10 or later) and Android (version 8 or later) smart devices



**ManTooth® APP FEATURES**

- Check target superheat and subcool by setting dewpoint and bubble point
- Additional monitoring, data logging and report generation
- Generates datalog file
- Available in English, French, Spanish, Dutch and German
- Data logging to record and document values during servicing
- Improved connectivity and reconnect process if signal is lost
- Ability to download logged data for graphing in Excel
- For iOS and Android devices
- Backwards compatible with existing ManTooth® devices (excluding vacuum gauge)

**APPLICATIONS**

- AC&R System Evaluation
- Evacuation
- Charging/Recovery
- Leak Testing



Vacuum Screen

P/T Screen



UPC #	Description
40860	P51-860 TITAN® Digital Manifold
40870	P51-870 TITAN® Digital Manifold
40875	P51-870 TITAN® Digital Manifold with ball valve, 5/16" hoses
40877	P51-870 TITAN® Digital Manifold with (2) YJACK™ wireless temperature clamps, ball valve and 5/16" hoses
UPC #	Optional/Replacement Parts
67030	Vacuum Sensor
10146	Backpack
67010	Temperature Probe Clamp
67061	YJACK™ Temperature Clamp (wireless)
21990	(3) 60" RYB (Standard Fittings); (1) 60" Y (3/8" str x 3/8" 45° Quick Coupler)
18160	60" Yellow, 3/8" straight x 3/8" 45°, PLUS II™ "B"
21985	60" 3 pak, standard fitting, PLUS II™ 1/4" hose
29985	60" 3 pak, compact ball valve, PLUS II™ 1/4" hose
29425	60" Blue, compact ball valve (1/4" x 5/16")
29465	60" Red, compact ball valve (1/4" x 5/16")
40844	P51 TITAN® Replacement Micro-USB Board



40860

# YJACK™ SERIES WIRELESS SENSORS

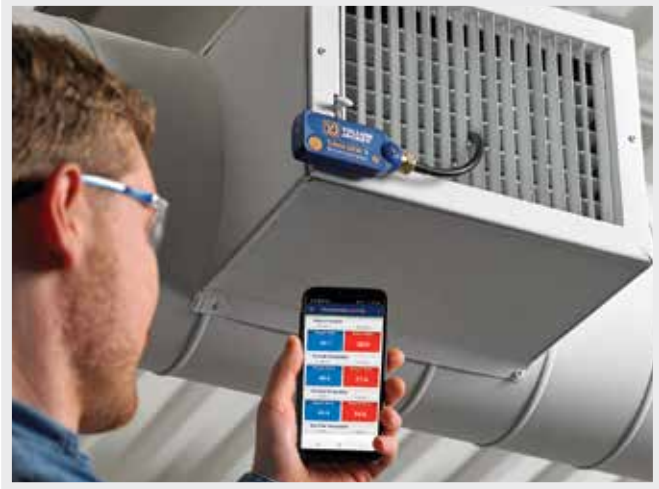

## YJACK™ FOR A MORE CONNECTED TECH

The YJACK™ Series is a network of devices that form a new platform offering a total HVAC/R diagnostics solution. Multiple devices can measure system and environmental parameters. When coupled with the P51 TITAN® digital manifold, the user has the necessary information for complete system diagnostics.

Each device utilizes Low Energy Bluetooth® (BLE) technology to interconnect with each other and any smart device: Android and iOS. All YJACK™ Series devices can also communicate directly with the P51-870 TITAN® Series Digital Manifold simultaneously. The YJACK VIEW™ App provides ease of access to all information measured by the YJACK™ Series of devices.



67060

### YJACK PATH™ RANGE EXTENDER

*Extend your working area and connect up to 8 devices for complete system analysis*



67061

### YJACK™ TEMPERATURE CLAMP

*Stop worrying about tangled wires with limited range*



67063

### YJACK DEW™ PSYCHROMETER

*Measure temperature, humidity, wet bulb, dew point and more in ambient air or ventilation ducting*



67062

### YJACK™ TEMPERATURE STRAP

*Easily measure temperature for pipes up to 6" diameter*



## YJACK PATH™ RANGE EXTENDER

*Extend your working area and connect up to (8) devices for complete system analysis*



- Connects and re-broadcasts up to (6) YJACK™ devices and (2) P51-870 TITAN® devices at one time
- Adds up to an additional 400 ft signal range to all YJACK™ and P51-870 TITAN® devices\*
- Amplifies signal strength through difficult to penetrate barriers
- Use to circumvent obstructions to your Bluetooth® signal
- Create perimeter with multiple YJACK PATH™ devices for network of connected devices
- Utilize multiple YJACK PATH™ devices to drastically increase line of sight range
- Compatible with YJACK DEW™, YJACK™ Temperature Clamp, YJACK™ Temperature Strap, and all P51-870 TITAN® devices (requires firmware version v2.0 or later)
- Compatible with the YJACK VIEW™ App
- Simple to operate, one push button start-up
- Operating Temperature: -0.4°F to 131°F (-18°C to 55°C)
- Storage Temperature: -40°F to 122°F (-40°C to 50°C)
- 75 hour continuous duty battery life (2 x AAA included)
- IP52 rated
- 2-year warranty

## YJACK™ TEMPERATURE CLAMP

*Stop worrying about tangled wires with limited range*



- Wireless measurements for surface temperature of pipes up to 1.25" diameter
- Temperature clamp provides strong, secure connection to system
- Flexible cable connection for easy access in small and difficult to reach areas
- Rotating mounting magnet for optimal Bluetooth® transmitter placement
- Bluetooth® 4.2 compliant low energy radio
- 400 ft line of sight signal range\*
- Compatible with YJACK VIEW™ App and P51-870 TITAN® devices (firmware version v2.0 or later)
- Rapid Response Time: 10 seconds to 90% of differential TYP\*\*
- Temperature Measurement Range: -40°F to 176°F (-40°C to 80°C)
- Temperature Measurement Accuracy: +/-1.0 °C TYP\*\*
- Operating Temperature: -0.4°F to 131°F (-18°C to 55°C)
- Storage Temperature: -40°F to 122°F (-40°C to 50°C)
- Long 1200 hour battery life (2x AAA included)
- IP52 rated
- 2-year warranty

## YJACK DEW™ (PSYCHROMETER)

*Measure temperature, humidity, wet bulb, dew point and more in ambient air or ventilation ducting*



- Wireless measurement of psychrometric parameters with ease
- Measures percent relative humidity, dry bulb temperature, wet bulb temperature, and dew point temperature
- Measure enthalpy change across evaporator coil for system operational efficiency
- Features 8" flexible steel wand for optimal sensor positioning within ventilation ducting
- Optimized sensor housing designed for increased air exchange and better response time
- High strength mounting magnet for secure attachment to ventilation systems
- Bluetooth® 4.2 compliant low energy radio
- 400 ft line of sight signal range\*
- Compatible with YJACK VIEW™ App and P51-870 TITAN® devices (firmware version v2.0 or later)
- Relative Humidity Measurement Range: 0 to 100% RH
- Relative Humidity Accuracy: +/- 2.0% RH TYP (10 to 90% RH)\*\*
- Temperature Measurement Range: -40°F to 257°F (-40°C to 125°C)
- Temperature Measurement Accuracy: +/- 0.2°C TYP (-10 to 80°C)\*\*
- Operating Temperature: -0.4°F to 131°F (-18°C to 55°C)
- Storage Temperature: -40°F to 122°F (-40°C to 50°C)
- Long 1500 hour battery life (2x AAA included)
- IP52 rated
- 2-year warranty

## YJACK™ TEMPERATURE STRAP

*Easily measure temperature for pipes up to 6" diameter*



- Wireless measurements for surface temperature of pipes up to 6" diameter
- Elastic strap creates secure connection and prevents loosening under vibration
- Easy to use quick-release latch for rapid connection and disconnection from system
- Flexible cable connection for easy access in small and difficult to reach areas
- Rotating mounting magnet for optimal Bluetooth® transmitter placement
- Bluetooth® 4.2 compliant low energy radio
- 400 ft line of sight signal range\*
- Compatible with YJACK VIEW™ App and P51-870 TITAN® devices (firmware version v2.0 or later)
- Rapid Response Time: 30 seconds to 90% of differential TYP\*\*
- Temperature Measurement Range: -40°F to 176°F (-40°C to 80°C)
- Temperature Measurement Accuracy: +/-1.5 °C TYP\*\*
- Operating Temperature: -0.4°F to 131°F (-18°C to 55°C)
- Storage Temperature: -40°F to 122°F (-40°C to 50°C)
- Long 1200 hour battery life (2x AAA included)
- IP52 rated

\*Radio interference and nearby obstructions may reduce signal strength

\*\*Results may vary with ambient conditions



## YJACK VIEW™ APP

The YELLOW JACKET® YJACK VIEW™ app provides seamless integration with YJACK™ and P51-870 TITAN® devices offering a complete HVAC/R system diagnostic solution. Just use your YJACK™ and P51-870 TITAN® devices with your smart phone for complete system analysis.



Easily receive and analyze live data from all powered on nearby YJACK™ and P51-870 TITAN® devices including system pressure, temperature, vacuum, and psychometrics. Includes a variety of session types useful for diagnosing any HVAC/R system.

### YJACK VIEW™ SMART APPLICATION:

- Measure HVAC/R system pressure, temperature, saturation temperature, superheat and subcooling
- Monitor system evacuation status
- Check indoor air comfort and system efficiency with psychrometric air calculations: percent relative humidity, dry bulb, wet bulb, and dew point temperature measurements
- Monitor status of all nearby YJACK™ and P51-870 TITAN® devices
- Customize data view for each measurement
- Freely switch between multiple simultaneous sessions without loss of data
- Create highly customized datalog reports which can be saved or emailed from your smart device
- Choose from 126 refrigerant profiles found in the REFPROP database
- Available on iOS (version 10 or later) and Android (version 8 or later) smart devices



### YJACK VIEW™ HIGHLIGHTS:

- Effortlessly create and manage a network of connected HVAC/R system diagnostic devices
- Compatible with all YJACK™ & P51-870 TITAN® devices (firmware version v2.0 and later)
- Includes all the features of the original Mantooth® App plus enhancements streamlined to maximize user experience
- No device connections necessary, seamlessly move in and out of range of devices without reconnecting or relaunching application
- Freely navigate between available session types, multiple sessions at one time
- New session types including Psychrometric Air Calculations and Available Device Manager
- Easily place and monitor status of all YJACK™ and P51-870 TITAN® devices from one screen
- Adjustable datalog formatting and multiple sampling intervals
- 126 refrigerant profiles from REFPROP database

## YJACK™ KITS



### YJACK VIEW™ SUPPORTED YELLOW JACKET® DEVICES:

- P51-870 TITAN® Digital Manifold
- YJACK™ Temperature Strap
- YJACK PATH™
- YJACK DEW™
- YJACK™ Temperature Clamp



UPC #	Description
67060	YJACK PATH™
67061	YJACK™ Temperature Clamp
67062	YJACK™ Temperature Strap
67063	YJACK DEW™ Psychrometer
67070	YJACK™ Temperature Clamp Kit; (2) YJACK™ Temperature Clamps, (1) YJACK PATH™
67071	YJACK™ Temperature/Humidity Kit; (2) YJACK™ Temperature Clamps, (2) YJACK DEW™ Psychrometers, (1) YJACK PATH™
40877	P51-870 TITAN® Digital Manifold with (2) YJACK™ Temperature Clamps, Ball Valve and 5/16" Hoses

CHARGING SYSTEMS  
GAUGES  
RECOVERY MACHINES  
VACUUM PUMP SYSTEMS  
VACUUM AND CHARGING HOSES  
HOSE ADAPTERS, VALVES & PARTS  
WIRELESS AND ELECTRONIC INSTRUMENTS  
LEAK DETECTORS AND MONITORS  
HEATING INSTRUMENTS  
SYSTEM TOOLS

## PRESSURE / TEMPERATURE

View system pressure and temperature data as reported by any combination of YJACK™ temperature devices or P51-870 TITAN® units. Easily select and favorite commonly used refrigerants for calculating system properties including saturation temperatures and calculated system superheat/subcooling. Effortlessly manipulate data view types, including traditional, large numeric format, analog gauge (pressure only) or graphically.



## PSYCHROMETRIC AIR CALCULATIONS

Analyze psychrometric data as reported by (2) YJACK DEW™ devices. Ensure maximum home comfort through wireless relative humidity, dry bulb, wet bulb, and dew point temperature calculations. Monitor efficiency across evaporator coil utilizing (2) YJACK DEW™ within ventilation ducting. View available data as traditional, large numeric format or graphically.



## ENHANCED DATALOGGING

Record data from one or all current session types as desired. Choose from a variety of sampling rates depending on user need. Live updates to selected devices, units, elevation, refrigerant selection appended to existing datalogs. Start and stop datalogging at will, save for later, or share via email for remote analysis.

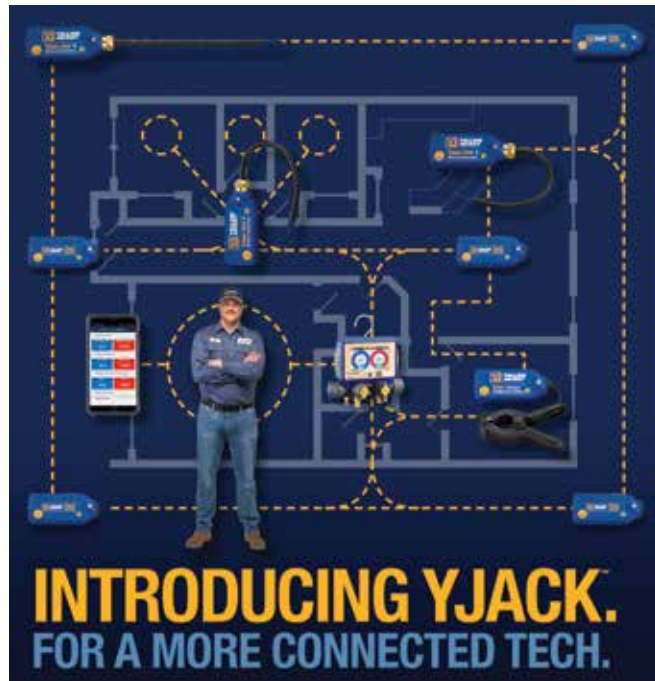

## EVACUATION

Monitor system vacuum as reported by a P51-870 TITAN® external wired vacuum sensor. Data can be displayed as traditional, large numeric format, analog gauge or graphically. Adjustable vacuum pressure target and hold timer ensures all refrigerant, moisture, and non-condensable gases are removed from the system during evacuation.



## AVAILABLE DEVICES

Effortlessly monitor the status of all YJACK™ and P51-870 TITAN® devices including reported numerical data, battery life and availability. Effectively create a perimeter of devices by placing YJACK PATH™ devices periodically throughout the work area, boosting the signal of all nearby YJACK™ and P51-870 TITAN® devices.



## STREAMLINED USER EXPERIENCE

Enhanced user interface focuses on streamlining the user experience by eliminating connection between YJACK™, P51-870 TITAN® and smart devices and providing a fluid environment allowing the user full control of system data types, data view, and datalogging.

## P51-870 TITAN® WITH YJACK™ TEMPERATURE CLAMPS



### 40877 INCLUDES:

- Vacuum sensor (P/N 67030)
- Set of (6) 60" manifold hoses: (3) RYB compact ball valves (P/N 29985); (1) Y 3/8" str x 3/8" 45° (P/N 18160); (2) compact ball valve 1/4" x 5/16" (P/Ns 29425 and 29465)
- (2) YJACK™ Temperature Clamps (P/N 67061)
- USB charging cable
- Backpack carrying case (P/N 10146)

UPC #	Description
67060	YJACK PATH™
67061	YJACK™ Temperature Clamp
67062	YJACK™ Temperature Strap
67063	YJACK DEW™ Psychrometer
67070	YJACK™ Temperature Clamp Kit; (2) YJACK™ Temperature Clamps, (1) YJACK PATH™
67071	YJACK™ Temperature/Humidity Kit; (2) YJACK™ Temperature Clamps, (2) YJACK DEW™ Psychrometers, (1) YJACK PATH™
40877	P51-870 TITAN® Digital Manifold with (2) YJACK™ Temperature Clamps, Ball Valve and 5/16" Hoses



- iPhone and iPad are registered trademarks of Apple Inc., registered in the U.S. and other countries.  
 - Android is a trademark of Google Inc.  
 - The Bluetooth® word mark and logos are registered trademarks owned by Bluetooth SIG, Inc. and any use of such marks by Ritchie Engineering is under license. Other trademarks and trade names are those of their respective owners.



# MANTOOTH® WIRELESS VACUUM GAUGE AND P/T GAUGE COMBINATION



The YELLOW JACKET® ManTooth®-PTV (67023) shown above provides vacuum and high- and low-side P/T readings. This full set includes dual non-tethered pressure/temperature gauges, two wired temperature clamps, and one interchangeable vacuum gauge. The single ManTooth®-PTV (67021) can be combined with an existing ManTooth® P/T device (67001) for adding wireless vacuum capability and/or expanding it to a full system analysis tool. Simply update your ManTooth® P/T app to version 2.0, connect to the 67020 hardware, and you're ready to go!

To enable mounting on 5/16" systems, add coupler 19221 (90°) or 19121 (straight).



## Product Features:

- Interchangeable/removable vacuum gauge
- Easy-to-clean vacuum sensor
- Built-in Schrader cores for easy refrigerant charging
- Operates with and without hoses attached
- Two year warranty
- High impact glass reinforced housing
- Rechargeable LiPo battery for long battery life
- Robust/rugged vacuum sensor
- Integral magnet for mounting on framework
- Integrated rubber side grip for easy handling

## App Features:

- Available in English, French, Spanish, Dutch, and German
- Data logging to record and document values during servicing
- Improved connectivity and reconnect process if signal is lost
- Ability to download logged data for graphing in Excel
- For iOS and Android devices
- Backwards compatible with existing ManTooth® Devices (excluding vacuum gauge)

UPC#	Description
67020	ManTooth®-V (Vacuum only) with side grip
67021	ManTooth®-PTV Single with side grip
67023	ManTooth®-PTV Dual with side grip
69030	Vacuum Sensor Cleaning Kit

UPC#	Replacement Parts
67030	Vacuum sensor
67012	USB cord
67014	Carrying case
93394	Tether cap
19020	Hose gaskets (10 pak)
19121	Straight 5/16" Flare quick connect x 1/4" Male coupler
19221	90° 5/16" Flare quick connect x 1/4" Male coupler
19302	Valve depressor (10 pak)
19305	Schrader valve (10 pak)

### Pressure/Temperature Specifications

Pressure Sensing Resolution	0.1 psi, 0.1 bar, 1 kPa, 0.001 MPa, 0.01 kg/cm <sup>2</sup>
Pressure Sensing Accuracy	0.5% of full scale at 25°C; 1% of full scale 55°F to 130°F; 2% of full scale -40°F to 248°F
Working Pressure	0 – 700 psia (48.3 bar)
Proof Pressure	Tolerable pressure without internal damage 1000 psia
Burst Pressure	Tolerable pressure without loss of seal 1500 psia
Temperature Sensor Range (Instrument)	Sensing element: -40°F to 266°F (-40°C to 130°C); Max Cord temp: 176°F (80°C); Max Clamp Temp: 203°F (95°C)
Temperature Display Resolution	0.1°F or °C
Temperature Accuracy (Instrument)	±0.2°C (±0.36°F)
Working Temperature	-4°F to 160°F (-20°C to 71°C) Limited by battery
Storage Temperature	-4°F to 160°F (-20°C to 71°C) - for best battery performance do not store at over 100°F (38°C)
Working Humidity	0-95% RH (non-condensing)
IP Class	IP 50
Bluetooth Range	70-90 ft. (Class 1) or 30-40 ft. (Class 2) in most cases (varies depending on the Bluetooth capability of smart device used). Under perfect conditions (clear line of sight and low interference) communications can extend up to 300 feet.
Bluetooth Radio	Class 1 Bluetooth 2.1 Radio
Size and weight	6" long x 1.6" wide x 2.3" thick (15.3 x 4 x 5.8 cm); 0.5 lbs (225 grams)
Superheat and Subcool	Automatically calculated by the ManTooth App
Max. and Min. Pressures	Displays and records the maximum and minimum pressures
Refrigerant Database	126 NIST refrigerant profiles included; upgradeable
Screenshot Feature	Save pressure and temperature readings from your sessions; automatically organize
Temperature Sensors	Capable of measuring 2 temperatures using high accuracy NTC thermistors
Pressure Transducers	67001/67003 – one pressure transducer; 67002 – two pressure transducers
System Attachment	Very small internal volume minimizes refrigerant loss during system analysis
Pressure Zeroing	Simple single button zeroing at the start of each session
Elevation Compensation	Enter elevation at the start of the session for effortless psia compensation
Battery	Rechargeable LiPo battery for 10+ hours continuous life

### Vacuum Specifications

Cord Length	Approximately 33"
Magnet Strength	8 lbs. holding force
Operational Temperature Range	10 – 122F 12 – 50C
Calibration	Calibration standards traceable to NIST
Resolution	.1 micron
Warm-Up Time and Response Time	Instant



69030



## MANTOOTH® WIRELESS DIGITAL PRESSURE/TEMPERATURE GAUGE



The YELLOW JACKET® ManTooth® Wireless Digital Pressure/Temperature Gauge provides wireless connection to your smart device so you can test the system without losing refrigerant (no hoses or manifolds necessary)!

The free downloadable ManTooth® RSA app wirelessly calculates and displays the system's actual pressures, temperatures, superheat and subcooling in an easy-to-read color format on your iPhone®, iPad® or Android™ device.

### Additional Features:

- Built-in Schrader ports to easily adjust refrigerant charge
- Range up to 400' (unobstructed)
- YELLOW JACKET® ManTooth® RSA app (free download)
- Two-year warranty
- Screenshot feature allows you to save pressure and temperature readings from your sessions which can be automatically organized by location and unit being serviced
- Share screenshots via e-mail right from your phone
- Easily track and store service history
- Rechargeable lithium polymer battery with 10 hours battery life

The ManTooth® Single Pressure Wireless Digital P/T Gauge includes a single hardware device and clamp. Two single units can be purchased in a case by ordering Part #67003.

For dual pressure readings, use two of the 67001 ManTooth® single pressure gauges or the 67002 ManTooth® Dual Pressure Unit which comes with a P/T module, tether unit and two temperature probe clamps. This unit also includes a convenient carrying case which can be purchased separately for the single pressure unit.

UPC#	Description
67001	ManTooth® Single Pressure Gauge (includes P/T Module with boot, temperature probe clamp, and USB cable)
67002	ManTooth® Dual Pressure Gauge Set (includes P/T Module and tether unit with boots, two temperature probe clamps, and two USB cables in case)
67003	Two (2) ManTooth® Single Pressure Gauges (includes two P/T Modules with boots, two temperature probe clamps, and two USB cables in case)

UPC#	Replacement Parts
67010	Clamp
67012	USB Cord
67013	Blue boot
67014	Carrying case
93394	Tether cap
19020	Hose gaskets (10 pak)
19302	Valve depressor (10 pak)
19305	Schrader valve (10 pak)

### Specifications:

Pressure Sensing Resolution	0.1 psi, 0.1 bar, 1 kPa, 0.001 MPa, 0.01 kg/cm <sup>2</sup>
Pressure Sensing Accuracy	0.5% of full scale at 25°C; 1% of full scale 55°F to 130°F; 2% of full scale -40°F to 248°F
Working Pressure	0 – 700 psia (48.3 bar)
Proof Pressure	Tolerable pressure without internal damage 1000 psia
Burst Pressure	Tolerable pressure without loss of seal 1500 psia
Temperature Sensor Range (Instrument)	Sensing element: -40°F to 266°F (-40°C to 130°C) Max Cord temp: 176°F (80°C); Max Clamp Temp: 203°F (95°C)
Temperature Display Resolution	0.1°F or °C
Temperature Accuracy (Instrument)	±0.2°C (±0.36°F)
Working Temperature	-4°F to 160°F (-20°C to 71°C)
Storage Temperature	-4°F to 160°F (-20°C to 71°C)
Working Humidity	0-95% RH (non-condensing)
IP Class	IP 50
Battery Life	10+ hours continuous
Range	70-90 ft. (Class 1) or 30-40 ft. (Class 2) in most cases (varies depending on the Bluetooth capability of smart device used). Under perfect conditions (clear line of sight and low interference) communications can extend up to 300 feet.
Bluetooth Radio	Class 1 Bluetooth 2.1 Radio
Size	6" long x 1.6" wide x 2.3" thick (15.3 x 4 x 5.8 cm)
Weight	0.5 lbs (225 grams)
Superheat and Subcool	Automatically calculated by the ManTooth App
Max. and Min. Pressures	Displays and records the max and min pressures
Refrigerant Database	98 NIST refrigerant profiles included; upgradeable
Screenshot Feature	Save pressure and temperature readings from your sessions which can be automatically organized by location and serviced unit
Temperature Sensors	Capable of measuring 2 temperatures using high accuracy NTC thermistors
Pressure Transducers	67001/67003 – one 67002 – two
System Attachment	Very small internal volume minimizes refrigerant loss during system analysis.
Pressure Zeroing	Simple single button zeroing at the start of each session
Elevation Compensation	Enter at start of session for effortless psia compensation
Battery	Rechargeable LiPo battery



- iPhone and iPad are registered trademarks of Apple Inc., registered in the U.S. and other countries.

- Android is a trademark of Google Inc.

- The Bluetooth® word mark and logos are registered trademarks owned by Bluetooth SIG, Inc. and any use of such marks by Ritchie Engineering is under license. Other trademarks and trade names are those of their respective owners.



# TITAN® 4-VALVE TEST & CHARGING MANIFOLD °F and °C



Forged aluminum alloy body makes this unit lightweight for handling ease with the durability and reliability required for repeated use.

- Fourth hose to enable connection to hi-/lo-sides, refrigerant tank and recovery unit or vacuum pump for diagnostics, evacuation and charging without switching hoses
- 3/8" Vacuum port for use with larger hose to cut evacuation time by up to 33% (all other fittings are 1/4")
- Large, easy-to-read 3-1/8" (80 mm) steel case red and blue, 1% accuracy (Class 1) gauges
- Front access for easy field recalibration
- Double "O" ring piston for reliability and long service life

- Exclusive 100 mesh filter in-line on all flare fittings helps keep out particulate material and extend the life of the seats
  - Contoured easy-grip handles for positive control; color-coded for ready identification
  - Sight glass to easily view refrigerant movement and condition during charging and recovery
  - Optional protective gauge boots available
  - Heavy duty hook won't pull out
  - Manifold and hose holder fittings 1/4"-3/8"-1/4"-1/4" unless otherwise identified
  - Made in the USA 
- Replacement parts on following pages.

TITAN® 4-Valve				
UPC#	Description - °F/°C	Gauges	Scale	Refrigerant
49914	Manifold only with 5/16"-3/8"-5/16"-5/16" anchor and service fittings	Red/Blue	kPa/psi	R-32/410A
49913	49914 with 60" PLUS II™ RYB and 3/8" x 45°	Red/Blue	kPa/psi	
49915	Manifold only with 5/16"-3/8"-1/4"-5/16" anchor fittings and 1/4"-3/8"-1/4"-1/4" service fittings	Red/Blue	kPa/psi	
49922	Manifold only	Liquid	bar/psi	R-22
49925	Manifold with 60" PLUS II™ RYB and 3/8" x 45°	Liquid	bar/psi	
49960	Manifold with 60" PLUS II™ compact ball valve RYB and 3/8" x 45°	Red/Blue	bar/psi	R-32/410A
49962	Manifold only	Red/Blue	bar/psi	
49964	Manifold only with 5/16-3/8-5/16-5/16" fittings	Red/Blue	bar/psi	
49965	Manifold with 60" PLUS II™ RYB and 3/8" x 45°	Red/Blue	bar/psi	
49966	Manifold only with 1/4" fittings	Red/Blue	bar/psi	
49971	Heat pump manifold only, 1/4x5/16x1/4 hose holder fittings	Black/Black	bar/psi	
49982	Manifold only	Liquid	bar/psi	
45925	Manifold with (3) black CO2 hoses and (1) yellow 72" PLUS II 3/8" x 45° hose	Liquid	bar/psi	R-744
UPC#	Description - °F	Gauges	Scale	Refrigerant
49973	Manifold only	Liquid	psi	R-22/410A
49977	Manifold with 60" PLUS II™ RYB and 3/8" x 45°	Liquid	psi	
49963	Manifold only	Red/Blue	psi	R-22/404A/410A
49967	Manifold with 60" PLUS II™ RYB and 3/8" x 45°	Red/Blue	psi	
49968	Manifold with 60" PLUS II™ compact ball valve RYB and 3/8" x 45°	Red/Blue	psi	
49283*	Manifold only	Red/Blue	psi	
49983	Manifold only	Red/Blue	psi	R-22/134a/404A
49987	Manifold with 60" PLUS II™ RYB and 3/8" x 45°	Red/Blue	psi	
49993	Manifold only	Liquid	psi	
49997	Manifold with 60" PLUS II™ RYB and 3/8" x 45°	Liquid	psi	R-134a/404A/407C
49932	Manifold only	Red/Blue	psi	
49935	Manifold with 60" PLUS II™ RYB and 3/8" x 45°	Red/Blue	psi	
49952	Manifold only	Liquid	psi	
49955	Manifold with 60" PLUS II™ RYB and 3/8" x 45°	Liquid	psi	
49900	Manifold with 72" PLUS II™ RYB and 3/8" x 45°	Red/Blue	psi	R-417A/422A/422D
49907	Manifold only	Red/Blue	bar/psi	R-448A/449A/452D
UPC#	Description - °C	Gauges	Scale	Refrigerant
49916	Manifold only	Red/Blue	bar/psi	R-12/22/502
49933	Manifold only	Red/Blue	bar/psi	
49912	Manifold only	Red/Blue	kPa/psi	R-22/134a/404A
49911	49912 manifold with 60" PLUS II™ RYB and 3/8" x 45°	Red/Blue	kPa/psi	
49931	Manifold only	Red/Blue	bar/psi	R-134a/404A/407F
49934	Manifold only; no sight glass	Red/Blue	bar/psi	
49936	Manifold only	Red/Blue	bar/MPa	R-134a/404A/407C
49956	Manifold only	Red/Blue	bar/psi	
49972	Heat pump manifold; no sight glass; 800 psi both gauges	Black/Black	bar/psi	

 \* Manifold comes standard with certified gauges. For more information on the certification of 3-1/8" gauges, see Gauges section.

For replacement parts, refer to the manual (also available at [yellowjacket.com](http://yellowjacket.com))

## CO<sub>2</sub> TEST AND CHARGING MANIFOLD

Manifold and hoses designed specifically for transcritical CO<sub>2</sub> (R-744) applications.



The YELLOW JACKET® TITAN® Test and Charging Manifold for transcritical CO<sub>2</sub> systems is constructed with a forged aluminum alloy body making it lightweight for handling ease and durability. No sightglass means added safety. It features true 45° SAE flare hoses 78" in length.

- Large, easy-to-read 3-1/8" (80 mm) liquid-filled red and blue, 1% accuracy (Class 1) gauges; psi/bar
- Proven, double "O"-ring piston for reliability and long service life
- Exclusive 100 mesh filter in-line on all flare fittings helps keep out particulate material and extends the life of the seats.
- Fourth hose to enable connection to hi/lo sides, refrigerant tank, and vacuum pump for diagnostics, evacuation and charging without switching hoses.
- 3/8" vacuum port for use with larger hose to cut evacuation time by up to 33% (all other fittings on unit are 1/4").
- Dedicated transcritical CO<sub>2</sub> hose 78" (200 cm) in length
- Designed and assembled in the USA 

### Specifications

Scales:	LP 30 in. Hg/1500 psi (-1/+105 bar)
	-60° to 85°F (-52° to 30°C)
	HP 0/3000 psi (0/210 bar)

4-valve forged aluminum body

Precision stainless steel valve feed screws

No sight glass for added safety

Class 1, 3-1/8" (80 mm), oil-filled, pulse-free

Fittings: (3) 1/4"; (1) 3/8" (vacuum application only)

Hoses: Three (3) black, 78" (200 cm), 1/4" SAE fittings (45°)

- Operating pressure 1740 psi (120 bar)

- High pressure copper gaskets

One (1) yellow, 78" (200 cm), 3/8" SAE fittings

- Operating pressure 594 psi (41 bar)

- Neoprene built-in gaskets

UPC#	Description
45925	TITAN® CO <sub>2</sub> Manifold with hoses (3) black and (1) yellow
45922	CO <sub>2</sub> 78" (200 cm) black replacement hose (single)
45923	Nylon CO <sub>2</sub> Manifold bag with handle and straps (optional)
14579	3/8" 78" (200 cm) yellow replacement hose (single)
49193	High pressure replacement gauge
49194	Low pressure replacement gauge

For replacement parts, refer to the manual (also available at [yellowjacket.com](http://yellowjacket.com))



# TITAN® 2-VALVE TEST & CHARGING MANIFOLD °F and °C



Comes with the same features and benefits as the TITAN® 4-valve unit but without the fourth hose. All fittings 1/4" unless otherwise noted.



Replacement parts on following page.

UPC#	Description - °F/°C	Gauges	Scale	Refrigerant
49814	Manifold only with 5/16" fittings	Red/Blue	kPa/psi	
49813	Manifold with 60" PLUS II™ 5/16x5/16" RYB	Red/Blue	kPa/psi	
49815	Manifold only with 5/16"-1/4"-5/16" anchor fittings and 1/4" service fittings	Red/Blue	kPa/psi	
49862	Manifold only with 1/4" fittings	Red/Blue	bar/psi	R-32/410A
49860	With 60" PLUS II™ compact ball valve RYB	Red/Blue	bar/psi	
49864	Manifold only with 5/16" fittings	Red/Blue	bar/psi	
49865	Manifold with 60" PLUS II™ RYB	Red/Blue	bar/psi	
49866	Manifold only with 5/16"-1/4"-5/16" anchor fittings and 1/4" service fittings	Red/Blue	bar/psi	
49849	With 72" PLUS II™ Acme fittings RYB	Red/Blue	psi	R-1234yf
UPC#	Description - °F	Gauges	Scale	Refrigerant
49883	Manifold only	Red/Blue	psi	
49887	Manifold with 60" PLUS II™ RYB	Red/Blue	psi	R-22/134a/404A
49889	Manifold with 60" PLUS II™ SealRight RYB	Red/Blue	psi	
49801	Manifold with 60" PLUS II™ SealRight RYB	Red/Blue	psi	
49863	Manifold only	Red/Blue	psi	
49281*	Manifold only	Red/Blue	psi	R-22/404A/410A
49867	Manifold with 60" PLUS II™ RYB	Red/Blue	psi	
49868	With 60" PLUS II™ compact ball valve RYB	Red/Blue	psi	
49832	Manifold only	Red/Blue	psi	
49835	Manifold with 60" PLUS II™ RYB	Red/Blue	psi	R-134a/404A/407C
49831	Manifold with 60" PLUS II™ SealRight RYB	Red/Blue	psi	
49847	With 72" PLUS II™ Acme fittings RYB	Red/Blue	psi	R-12/22/134a
UPC#	Description - °C	Gauges	Scale	Refrigerant
49816	Manifold only	Red/Blue	bar/psi	R-12/22/502
49833	Manifold only	Red/Blue	bar/psi	
49812	Manifold only	Red/Blue	kPa/psi	R-22/134a/404A
49811	49812 with 60" PLUS II™ RYB	Red/Blue	kPa/psi	
49836	Manifold only	Red/Blue	bar/MPa	R-134a/404A/407C
49856	Manifold only	Red/Blue	bar/psi	
40922	Manifold only with 5/16" fittings	Red/Blue	MPa	R-32/410A



\* Manifold comes standard with certified gauges.

For replacement parts, refer to the manual (also available at [yellowjacket.com](http://yellowjacket.com))

## PROTECTIVE GAUGE BOOTS

For 2-1/2" (63.5 mm), 3-1/8" (80 mm)



Rubber boots slip easily around gauges to cushion and protect them from impact.

- Fit 2-1/2" and 3-1/8" gauges without covering easy access recalibration screw
- Color-coded red or blue to match gauge
- Made in the USA

UPC#	Description
49010	2-1/2" Polycarbonite Lens
49090	2-1/2" Set of gauge boots
49091	2-1/2" Red protective gauge boot
49092	2-1/2" Blue protective gauge boot
49100	3-1/8" Replacement crystal
49190	3-1/8" Set of gauge boots
49191	3-1/8" Red protective gauge boot
49192	3-1/8" Blue protective gauge boot

## TITAN® 4-VALVE MANIFOLD REPLACEMENT PARTS

GAUGES

RECOVERY  
MACHINES

VACUUM PUMP  
SYSTEMS

VACUUM AND  
CHARGING HOSES

HOSE ADAPTERS,  
VALVES & PARTS

WIRELESS AND  
ELECTRONIC  
INSTRUMENTS

LEAK DETECTORS  
AND MONITORS

HEATING  
INSTRUMENTS

SYSTEM TOOLS

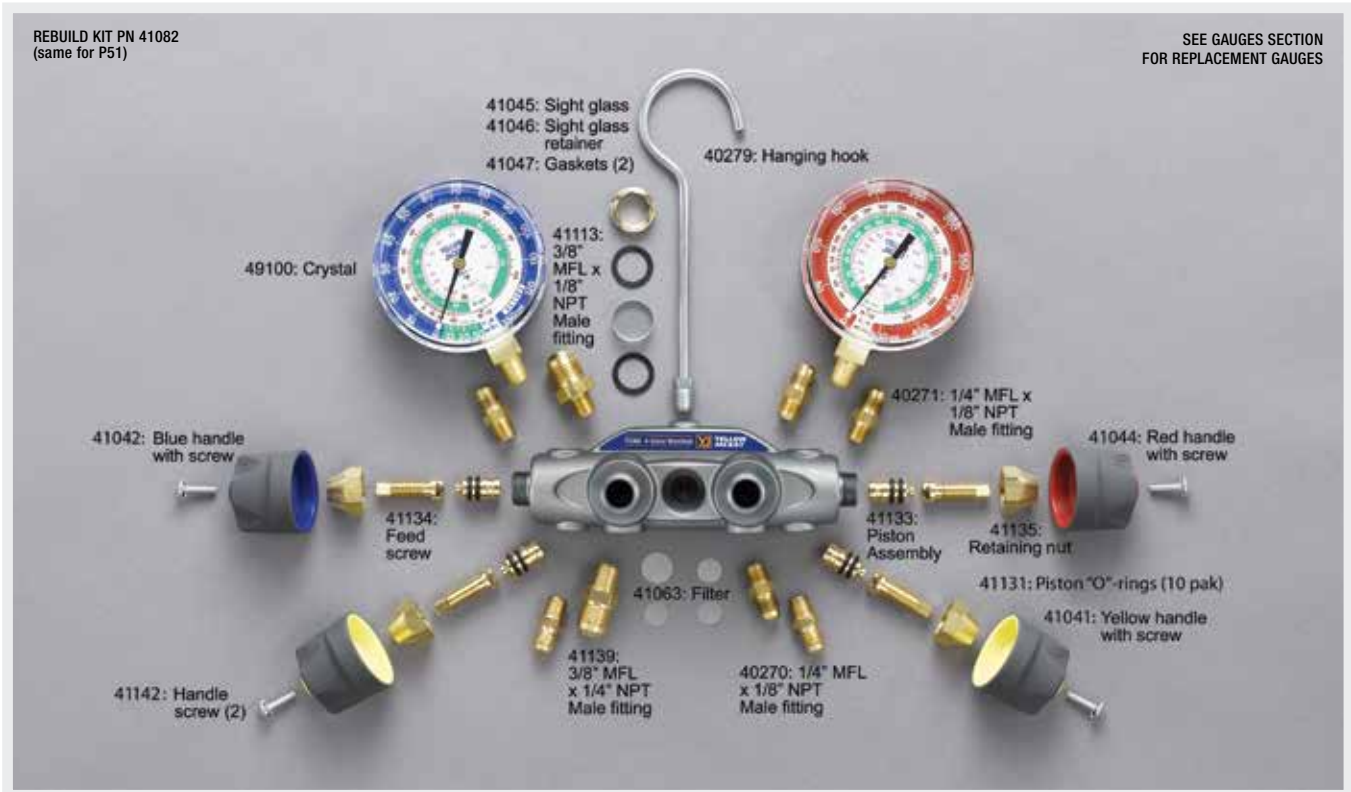

## TITAN® 2-VALVE MANIFOLD REPLACEMENT PARTS

WIRELESS AND  
ELECTRONIC  
INSTRUMENTS

LEAK DETECTORS  
AND MONITORS

HEATING  
INSTRUMENTS

SYSTEM TOOLS



# CO<sub>2</sub> TEST AND CHARGING MANIFOLD REPLACEMENT PARTS

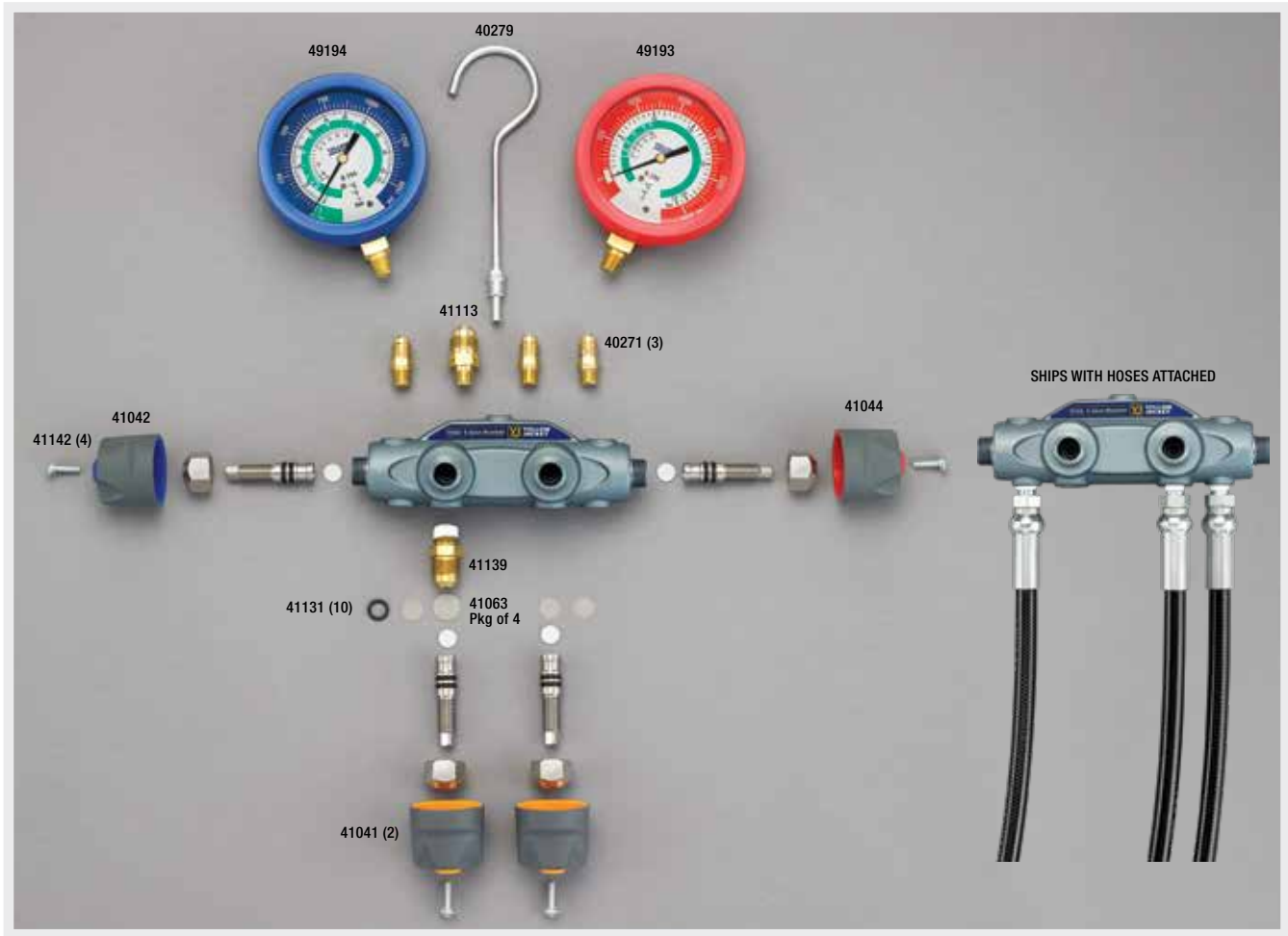

GAUGES

RECOVERY MACHINES

VACUUM PUMP SYSTEMS

VACUUM AND CHARGING HOSES

HOSE ADAPTERS, VALVES & PARTS

WIRELESS AND ELECTRONIC INSTRUMENTS

LEAK DETECTORS AND MONITORS

HEATING INSTRUMENTS

SYSTEM TOOLS





## BRUTE II® 4-VALVE TEST & CHARGING MANIFOLD °F and °C



Replacement parts available.

The *BRUTE II*® 4-Valve Test and Charging Manifold provides the flow that's proven faster than any conventional manifold. The aluminum alloy body is forged for strength and reliability with 3/8" bores through the body to speed the job.

- Fourth hose enables connection to hi-/lo-sides, refrigerant tank and recovery unit or vacuum pump for diagnostics, evacuation and charging without switching hoses
- Available in 1/4" hi-/lo-sides with 3/8" vacuum port for regular jobs, or 3/8" hi-/lo-sides with 1/2" vacuum port for larger systems

- Front access for easy field recalibration



- Double "O" ring piston for reliability and long service life
- Exclusive 100-mesh filter in-line on all flare fittings helps keep out particulate material and extend the life of the seat
- Contoured easy-grip handles for positive control; color-coded for ready identification
- Sight glass to easily view refrigerant movement and condition during charging and recovery
- Heavy duty hook won't pull out
- Also available with 3-1/2" (90 mm) red and blue liquid-filled gauges
- Manifold and hose holder fittings 1/4"-3/8"-1/4"-1/4" unless otherwise identified
- Made in the USA 

### BRUTE II® 4-Valve

UPC#	Description - °F/°C	Vacuum port	Hi/Lo charge	Gauges	Scale	Refrigerant
46001	Manifold only	3/8"	1/4"	Liquid	bar/psi	R-410A
46021	Manifold only	3/8"	1/4"	Liquid	bar/psi	R-22
46026	Manifold with 72" <i>PLUS II</i> ™ RYB and 3/8" x 45°	3/8"	1/4"	Liquid	bar/psi	R-22
46000	Manifold only	3/8"	1/4"	Red/Blue	bar/psi	R-32/410A
46003	Manifold with 60" <i>PLUS II</i> ™ compact ball valve RYB and 3/8" x 45°	3/8"	1/4"	Red/Blue	bar/psi	
46160	Manifold only with 5/16"-3/8"-1/4"-5/16" anchor and 1/4" service fittings	-	-	Red/Blue	bar/psi	
46170	Manifold only with 5/16"-3/8"-5/16"-5/16" anchor and service fittings	-	-	Red/Blue	bar/psi	
46174	Manifold only with 5/16"-3/8"-1/4"-5/16" anchor and 1/4" service fittings	-	-	Red/Blue	kPa/psi	
46176	Manifold only with 5/16"-3/8"-5/16"-5/16" anchor and service fittings	-	-	Red/Blue	kPa/psi	
UPC#	Description - °F	Vacuum port	Hi/Lo charge	Gauges	Scale	Refrigerant
46011	Manifold only	3/8"	1/4"	Liquid	psi	R-22/410A
46010	Manifold only	3/8"	1/4"	Red/Blue	psi	R-22/404A/410A
46013	Manifold with 60" <i>PLUS II</i> ™ compact ball valve RYB and 3/8" x 45°	3/8"	1/4"	Red/Blue	psi	
49291*	Manifold only	3/8"	1/4"	Red/Blue	psi	
46022	Manifold with 60" <i>PLUS II</i> ™ RYB and 3/8" x 45°	3/8"	1/4"	Red/Blue	psi	R-134a/404A/407C
46030	Manifold only	3/8"	1/4"	Red/Blue	psi	
46031	Manifold only	3/8"	1/4"	Liquid	psi	
46032	Manifold with 60" <i>PLUS II</i> ™ RYB and 3/8" x 45°	3/8"	1/4"	Red/Blue	psi	
46038	Manifold with 72" <i>PLUS II</i> ™ RYB and 3/8" x 45°	3/8"	1/4"	Liquid	psi	
46040	Manifold only	3/8"	1/4"	Red/Blue	psi	R-22/134a/404A
46041	Manifold only	3/8"	1/4"	Liquid	psi	
46042	Manifold with 60" <i>PLUS II</i> ™ RYB and 3/8" x 45°	3/8"	1/4"	Red/Blue	psi	
46043	Manifold with 60" <i>PLUS II</i> ™ compact ball valve RYB and 3/8" x 45°	3/8"	1/4"	Red/Blue	psi	
46048	Manifold with 72" <i>PLUS II</i> ™ RYB and 3/8" x 45°	3/8"	1/4"	Liquid	psi	
UPC#	Description - °C	Vacuum port	Hi/Lo charge	Gauges	Scale	Refrigerant
46180	Manifold only	3/8"	1/4"	Red/Blue	bar/psi	R-12/22/502
46130	Manifold only	3/8"	1/4"	Red/Blue	bar/MPa	R-134a/404A/407C
46190	Manifold only	3/8"	1/4"	Red/Blue	bar/psi	
46140	Manifold only	3/8"	1/4"	Red/Blue	bar/psi	
BRUTE II® 4-Valve Commercial						
UPC#	Description - °F/°C	Vacuum port	Hi/Lo charge	Gauges	Scale	Refrigerant
46081	Manifold only	1/2"	3/8"	Liquid	bar/psi	R-22
46084	Manifold with 3 at 3/8" x 60" heavy duty - Straight x 45° and 1 at 1/2" x 60" heavy duty - Straight x Straight	1/2"	3/8"	Liquid	bar/psi	
UPC#	Description - °F	Vacuum port	Hi/Lo charge	Gauges	Scale	Refrigerant
46090	Manifold only	3/8"	3/8"	Red/Blue	psi	R-22/134a/404A
46091	Manifold only	1/2"	3/8"	Liquid	psi	
46092	Manifold with 4 at 3/8" x 60" heavy duty - Straight x 45°	3/8"	3/8"	Red/Blue	psi	
46094	Manifold with 3 at 3/8" x 60" heavy duty - Straight x 45° and 1 at 1/2" x 60" heavy duty - Straight x Straight	1/2"	3/8"	Liquid	psi	



\* Manifold comes standard with certified gauges. For more information on the certification of 3-1/8" gauges, see Gauges section.

For replacement parts, refer to the manual (also available at [yellowjacket.com](http://yellowjacket.com))

# BRUTE II® MANIFOLD REPLACEMENT PARTS

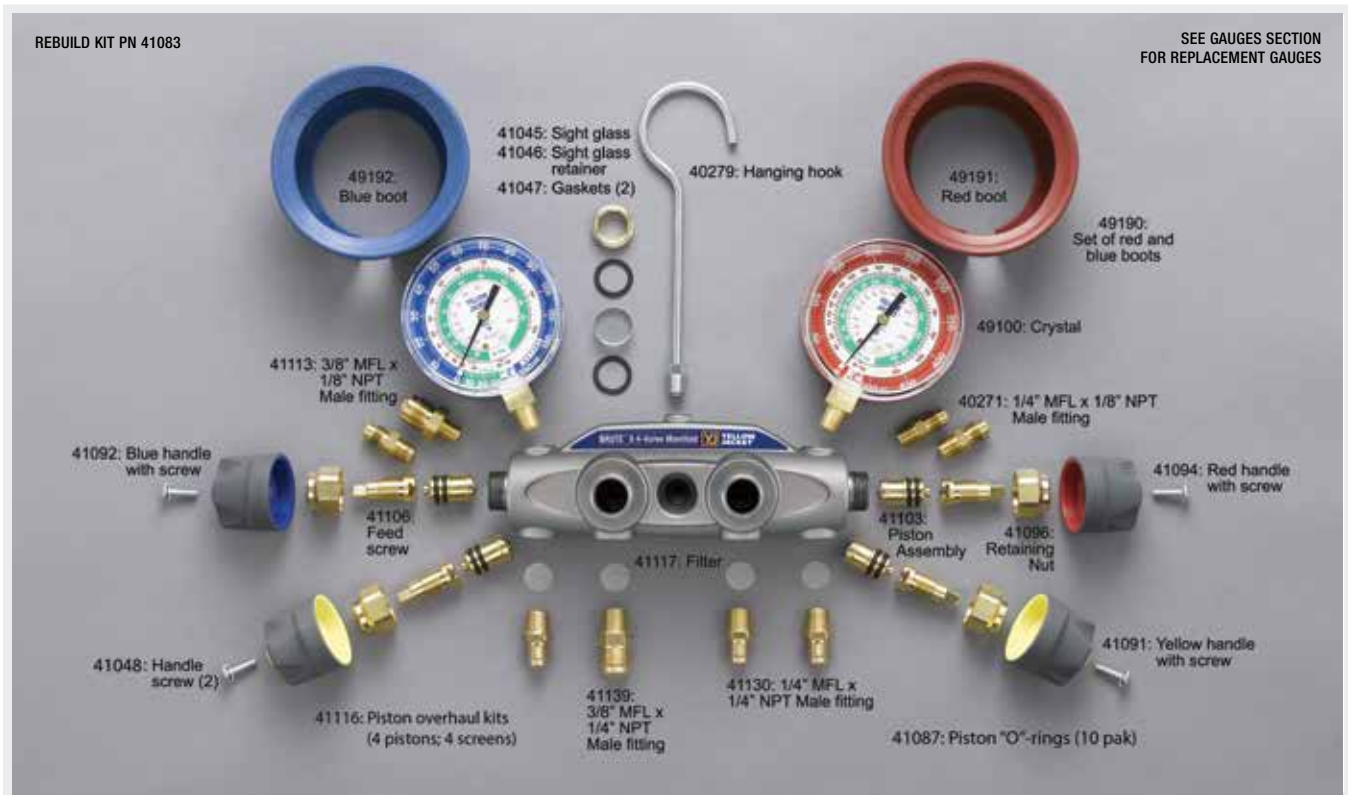

GAUGES

RECOVERY MACHINES

VACUUM PUMP SYSTEMS

VACUUM AND CHARGING HOSES

HOSE ADAPTERS, VALVES & PARTS

# SERIES 41 MANIFOLD REPLACEMENT PARTS

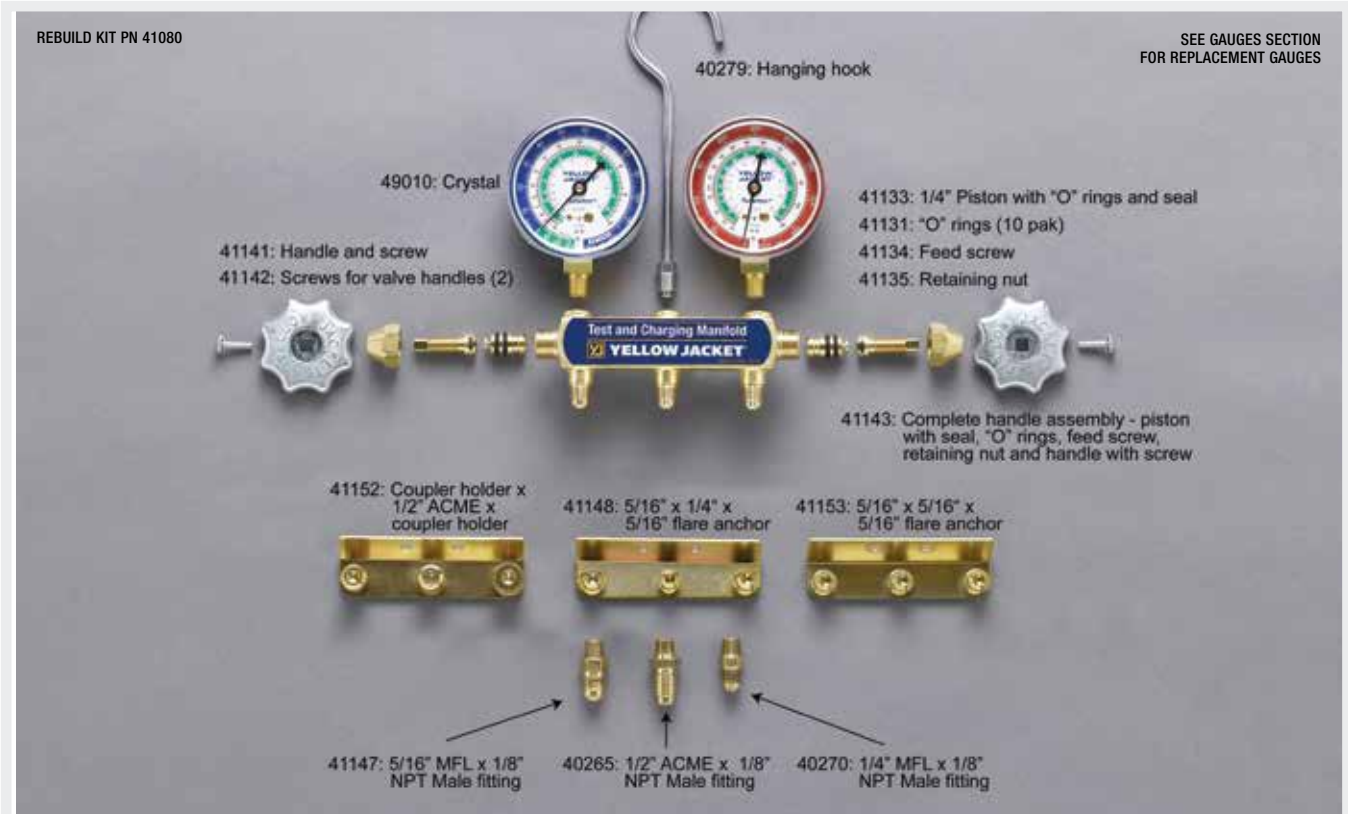

WIRELESS AND ELECTRONIC INSTRUMENTS

LEAK DETECTORS AND MONITORS

HEATING INSTRUMENTS

SYSTEM TOOLS

# SERIES 41 MANIFOLDS

°F and °C with 2-1/2" (63.5 mm) gauges



Forged body is solid brass for durability. Full porting maximizes capacity. Metal valve handles are full size for easy operation. Hose anchors are forged into back of body at 45°.

- Flutterless™ technology means surge protector and silicone dampened movement helps minimize needle pulsation for easier, more accurate readings
- Sliding double “O” ring pistons reduces wear
- Most manifolds include color-coded YELLOW JACKET® charging hoses
- Easy-to-read 2-1/2" (63.5 mm) steel case gauges with 3-2-3% accuracy (Class B)
- Limited lifetime warranty on manifold bar and valves – not gauges. See warranty information for details
- Made in the USA 



Series 41 Manifolds			
UPC#	Description - °F and °C - Red/Blue	Scale	Refrigerant
42051	Heat pump manifold only, 1/4-5/16-1/4"	bar/psi	R-410A
42054	With 60" PLUS II™ hoses (two 1/4x5/16" ball valve and one 1/4x1/4" ball valve)	bar/psi	
41712	Manifold only	kg/cm <sup>2</sup> /psi	R-410A
41703	With 60" PLUS II™ FLEXFLOW™ hoses	kg/cm <sup>2</sup> /psi	
41709	With 60" PLUS II™ standard fittings	kg/cm <sup>2</sup> /psi	
41715*	With 60" PLUS II™ standard fittings	kg/cm <sup>2</sup> /psi	
41710	With 60" PLUS II™ heavy duty black standard fittings	kg/cm <sup>2</sup> /psi	
41702	With 60" PLUS II™ heavy duty black compact ball valve fittings	kg/cm <sup>2</sup> /psi	
42715	With 60" PLUS II™ compact ball valve fittings	kg/cm <sup>2</sup> /psi	
41711*	With 60" PLUS II™ compact ball valve fittings	kg/cm <sup>2</sup> /psi	
41652	Manifold only with 5/16, 1/4", 5/16" hose fittings	bar/psi	R-32/410A
UPC#	Description - °F - Red/Blue	Scale	Refrigerant
41212	Manifold only	psi	R-12/22/502
41213	With 36" PLUS II™ standard fittings	psi	
41220	With 48" PLUS II™ standard fittings	psi	
41215	With 60" PLUS II™ standard fittings	psi	
41219	With 72" PLUS II™ standard fittings	psi	
44213	With 36" PLUS II™ SealRight fittings	psi	
44220	With 48" PLUS II™ SealRight fittings	psi	
44215	With 60" PLUS II™ SealRight fittings	psi	
44219	With 72" PLUS II™ SealRight fittings	psi	
42215	With 60" PLUS II™ compact ball valve fittings	psi	
42219	With 72" PLUS II™ compact ball valve fittings	psi	
41312	Manifold only	psi	
41313	With 36" PLUS II™ standard fittings	psi	
41311	With 48" PLUS II™ standard fittings	psi	
41315	With 60" PLUS II™ standard fittings	psi	
41319	With 72" PLUS II™ standard fittings	psi	
43313	With 36" PLUS II™ standard fittings	psi	
44313	With 36" PLUS II™ SealRight fittings	psi	
44315	With 60" PLUS II™ SealRight fittings	psi	
44319	With 72" PLUS II™ SealRight fittings	psi	
42315	With 60" PLUS II™ compact ball valve fittings	psi	R-22/134a/404A
41202	Manifold only	psi	
41209	With 36" PLUS II™ standard fittings	psi	
41211	With 60" PLUS II™ standard fittings	psi	
UPC#	UPC# Description - °C - Red/Blue	Scale	Refrigerant
41292	Manifold only	kg/cm <sup>2</sup> /psi	R-12/22/502
41293	With 36" PLUS II™ standard fittings	kg/cm <sup>2</sup> /psi	
41295	With 60" PLUS II™ standard fittings	kg/cm <sup>2</sup> /psi	
41299	With 72" PLUS II™ standard fittings	kg/cm <sup>2</sup> /psi	
41382	Manifold only	bar/psi	R-134a/404A/507
41353	Manifold with 36" PLUS II™ standard fittings	bar/psi	
41355	Manifold with 60" PLUS II™ standard fittings	bar/psi	
43355	Manifold with 60" PLUS II™ standard fittings	bar/psi	
41392	Manifold only	kg/cm <sup>2</sup> /psi	
41363	Manifold with 36" PLUS II™ standard fittings	kg/cm <sup>2</sup> /psi	
41365	Manifold with 60" PLUS II™ standard fittings	kg/cm <sup>2</sup> /psi	
43365	Manifold with 60" PLUS II™ standard fittings	kg/cm <sup>2</sup> /psi	
41332	Manifold only	bar/psi	R-134a/404A/407C
40944	Manifold only with 1/4" ports and 5/16" hose fittings	bar/MPa	R-410A
41781	Manifold only with 5/16" fittings	bar/MPa	
41780	Manifold only with 1/4" fittings	bar/MPa	

\*Special R-410A hose - R/B hoses are 1/4" x 45° 5/16" end; Y hose is 1/4" x 45° 1/4" end.

For replacement parts, refer to the manual (also available at [yellowjacket.com](http://yellowjacket.com))

CHARGING SYSTEMS

GAUGES

RECOVERY MACHINES

VACUUM PUMP SYSTEMS

VACUUM AND CHARGING HOSES

HOSE ADAPTERS, VALVES & PARTS

WIRELESS AND ELECTRONIC INSTRUMENTS

LEAK DETECTORS AND MONITORS

HEATING INSTRUMENTS

SYSTEM TOOLS



## SERIES 41 MANIFOLDS

°F and °C with 3-1/8" (80 mm) gauges



Series 41 manifolds are also available with larger, easier to read 3-1/8" color-coded gauges in rugged steel cases with polycarbonate crystals. These gauges feature 1% accuracy (Class 1) for an exact reading in critical charge systems.

- Color-coded scales
- Sliding double "O" ring pistons reduce wear
- Long life nylon seats
- Forged brass body for durability
- Full porting maximizes capacity and flow
- Some models include color-coded, 60" PLUS II™ hoses with standard 1/4" flare fittings
- Hose assemblies UL recognized for 4000 psi (275 bar) burst and 800 psi (55 bar) working pressure. File# SA9737
- Made in the USA

## SERIES 41 DELUXE MANIFOLDS

°F Class 1 (1% accuracy) brass gauges



All the same features as the regular "Series 41" with 1% accuracy (Class 1) brass gauges

- Upgraded movement with phosphor bronze plates, brass gears and pinions. Dissimilar parts create less friction and last longer. FlutterLess™ technology included
- Polished solid brass case with glass crystals
- Made in the USA

Box	Clamshell			
UPC#	UPC#	Description - °F/°C	Scale	Refrigerant
41863	-	Manifold only with 5/16"-1/4"-5/16" anchor fittings and 1/4" service fittings - red/blue gauges	kPa/psi	R-32/410A
41652	-	Manifold only with 5/16", 1/4", 5/16" anchor and 1/4" service fittings	bar/psi	
41659	-	Manifold only with 5/16" anchor fittings	bar/psi	
-	42021	Manifold only	bar/psi	
-	42024	Manifold with 60" PLUS II™ standard fittings	bar/psi	
41862	-	Manifold only with 5/16" anchor and service fittings	kPa/psi	
-	41865	41862 with 60" PLUS II™ 5/16" fittings	kPa/psi	
UPC#	UPC#	Description - °F - Red/Blue	Scale	Refrigerant
-	41842	Manifold only	psi	R-12/22/134a
-	42007	Manifold with 60" PLUS II™ standard fittings	psi	
-	41846	Manifold with 72" PLUS II™ with couplers	psi	
-	42001	Manifold only	psi	R-22/404A/410A
-	49271*	Certified 42001 manifold	psi	
-	42004	Manifold with 60" PLUS II™ standard fittings	psi	
-	42201	With 60" PLUS II™ compact ball valve fittings	psi	
-	42005	Manifold only	psi	
-	49272*	Certified 42005 manifold	psi	R-22/134a/404A
-	42006	Manifold with 60" PLUS II™ standard fittings	psi	
-	42205	With 60" PLUS II™ compact ball valve fittings	psi	
-	41209	With 36" PLUS II™ standard fittings	psi	
-	41209	With 36" PLUS II™ standard fittings	psi	
UPC#	UPC#	Description - °C - Red/Blue	Scale	Refrigerant
-	41622	Manifold only	bar/psi	R-22/134a/404A
-	41852	Manifold only	kPa/psi	
-	41855	Manifold with 60" PLUS II™ standard fittings	kPa/psi	
-	41632	Manifold only	bar/psi	R-12/134a/413A
-	42031	Manifold only	psi	R-22/404A/410A
-	42034	With 60" PLUS II™ hose, standard fittings	psi	R-22/404A/410A
-	41866	Manifold only	bar/psi	R600A/600/290
41784		Manifold only with 5/16" fittings	MPa	R-32/410A



\* Manifold comes standard with certified gauges. For more information on the certification of 3-1/8" gauges, see Gauges section.

## NH<sub>3</sub> AMMONIA MANIFOLD

UPC#	Description
40190	Manifold body with valves
40192	Manifold and gauges
40193	Manifold and gauges with three NHA 48" hoses
40199	Replacement valve assembly
41131	"O"-rings (10 pak)
41142	Replacement screw
41151	Hose anchor

This heavy duty manifold features cast iron body and full size metal handles. Dual temperature/pressure R717 gauge has bar with °C and psi with °F ammonia scales.

- Finger-tight one-piece valve stem for positive seal on nylon seat
- Easy, accurate valve adjustment
- Use only with NH<sub>3</sub> rated hoses
- Made in the USA



## SERIES 41 DIGITAL MANIFOLDS

°F and °C with 3 1/8" backlit LCD gauges



When clear, swift and accurate readings meet quality and precision measurements.

The YELLOW JACKET® Series 41 Digital Manifold combines the advantages of digital technology with the proven Series 41 2-valve brass manifold. The 3-1/8" backlit LCD gauges provide easy-to-read accurate measurements for system pressures. Each interchangeable gauge is capable of handling maximum pressures of 800 psi, so there are no worries about over-pressurizing. Pre-programmed with 21 most common refrigerants, the Series 41 Digital Manifold will provide clear, swift and accurate pressure measurements for all your system applications.

The forged body of the manifold is constructed of solid brass for durability. Full porting maximizes capacity, and the metal valve handles are full size for easy operation. For added security, the hose anchors are forged into the back of body at 45°.

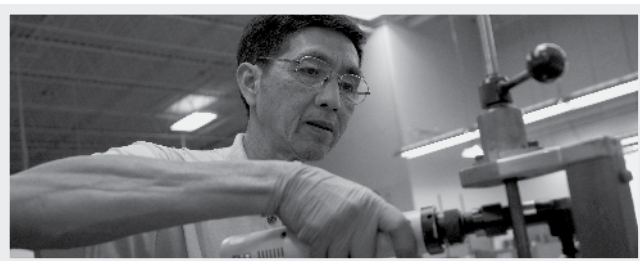

### Gauge Specifications:

- Pressure Range: -14.7 ~ 800 psi (-1 ~ 54.4 bar)
- Unit (Pressure): psi / bar / MPa / kg/cm<sup>2</sup> / kPa
- Working Temperature: 14°F ~ 140°F (-10°F ~ 60°F)
- Pressure Accuracy: ±0.5% F.S @71.6~82.4°F (@22~28°F)
- Unit (Temperature): °F/°C
- Working Humidity: 35~85%
- Sampling Rate = 1.2 sec max.
- Auto-off: 10 minutes
- Zero pressure function
- Power Supply: Battery CR123A (3.0V, 1400mAh)
- Battery Life: 2 years for continuous operation without backlight
- Warranty: One year

### Refrigerants:

R-22, R-23, R-32, R-124, R-134A, R-290, R-404A, R-407C, R-407F, R-408A, R-410A, R-417A, R-427A, R-444B, R-448A, R-449A, R-452A, R-507, R-600, R-1234YF, R1270

### Manifold Specifications:

- Forged brass body for durability
- Sliding double "O" ring pistons reduce wear
- Long life nylon seats
- Full porting maximizes capacity and flow
- Hose assemblies UL recognized for 4000 psi (275 bar) burst and 800 psi (55 bar) working pressure. File# SA9737
- Assembled in the USA 

UPC#	Description
46060	Series 41 Digital Manifold
46062	Series 41 Digital Manifold with 3-pack PLUS II™ hoses with compact ball valves
UPC#	Replacement Parts
49017	Replacement gauge

# HEAT PUMP MANIFOLD



- Large 3-1/8" gauges feature black steel cases with polycarbonate crystal
- Hi- and lo-side gauges read up to 800 psi
- Larger dials are bold and easy to read
- Dials with 1% accuracy (Class 1) full scale movement provide the level of accuracy necessary for critical charge systems
- Proven sliding double "O" ring pistons reduce wear
- Long life nylon seats
- Forged brass body for durability
- Full porting maximizes capacity and flow
- Full-size metal valve handles for easy operation
- Hose assemblies UL recognized for 4000 psi (275 bar) burst and 800 psi (55 bar) working pressure (File # SA9737)
- Made in the USA

The YELLOW JACKET® Heat Pump Manifold features two 800 psi gauges to read all heat pump pressure conditions. Traditional lo-side manifold gauges can be susceptible to damage when heat pumps go into heating mode. Because the lo-side gauge of the YELLOW JACKET Heat Pump Manifold is also designed for pressures up to 800 psi, it can read the pressure whether the pump is in heating mode, cooling mode or transition.

UPC#	Description	Hoses	Hose holder fittings	Refrigerants
42041	Heat pump manifold	None	1/4-1/4-1/4"	
42044	Heat pump manifold	(3) 60" black PLUS II™ 1/4" hoses	1/4-1/4-1/4"	R-22/ R-407C/ R-410A
49133	High side replacement gauge	800 psi, °F	-	
49134	Low side replacement gauge	800 psi, °F	-	
42052	Heat pump manifold	None	1/4-1/4-1/4"	
42055	Heat pump manifold	(3) 60" black PLUS II™ 1/4" ball valve hoses	1/4-1/4-1/4"	
42051	Heat pump manifold	None	5/16-1/4-5/16"	
42054	Heat pump manifold	60" black PLUS II™ 1/4" ball valve hoses; (2) 5/16" on service end (1) 1/4" on service end	5/16-1/4-5/16"	R-410A
49971	Heat Pump Manifold	Manifold only	5/16-3/8-1/4-5/16"	
49141	High side replacement gauge	800 psi (55 bar), °C and °F	-	
49142	Low side replacement gauge	800 psi (55 bar), °C and °F	-	





## LIQUID CHARGER



Liquid charging is recommended when charging blends into refrigeration and air conditioning systems, and a liquid charger adapter is necessary for safe and fast liquid charging through the low pressure side of a system.

- The adapter connects to the cylinder valve or refrigerant can
- To protect the compressor, adapter orifice reduces liquid flow to a level below compressor capacity
- Eliminates the time and work of heating cylinders 

UPC#	Description
41123	1/4" Liquid charging adapter
41124	5/16" Liquid charging adapter
41132	1/4" "O" ring and orifice
41138	5/16" "O" ring and orifice

## "O" RING LUBRICANT

To lubricate "O" rings in manifolds when pistons or "O" rings are being replaced. Use sparingly.



UPC#	Description
41118	"O" ring lubricant (0.75 oz.)

## MANIFOLD PARTS KIT

For Series 41, TITAN™, and BRUTE II™ Manifolds



UPC#	Description
41099	Complete kit
41105	Box only with label
Kit contents/quantity	
41041	Yellow handle with screw - TITAN (4)
41042	Blue handle with screw - TITAN (3)
41044	Red handle with screw - TITAN (3)
41048	Handle screws (2) - Series 41/TITAN/BRUTE II (6 sets)
41061	Sight glass (1), retainer (1), gaskets (2) - BRUTE II/TITAN (4 sets)
41090	Handle screws (2) - Older style BRUTE (6 sets)
41091	Yellow handle with screw - BRUTE II (4)
41092	Blue handle with screw - BRUTE II (3)
41094	Red handle with screw - BRUTE II (3)
41096	Valve retaining nut - BRUTE II (4)
41103	3/8" Piston - BRUTE II (8)
41106	Feed screw - BRUTE II (4)
41134	Feed screw - Series 41/TITAN (6)
41135	Valve retaining nut - Series 41/TITAN (6)
41141	Metal handle with screw - Series 41 (4)
41142	Handle screws (2) - Series 41/TITAN/BRUTE II (6 sets)
41133	1/4" Piston - Series 41/TITAN (6)

## MANIFOLD CARRYING CASES



Heavy duty blue blow- molded cases are available in four different manifold/hose configurations. Includes handle and a long life top hinge. 

UPC#	Description
40263	Series 41 case - 12 1/4" x 8" x 4 1/4"
40822	Case for BRUTE™ II and Refrigeration System Analyzer (40815) - 6-1/2" x 17" x 14"

## MANIFOLD PARTICULATE FILTER

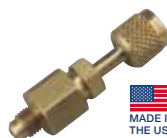



As manifold usage changes with more recovery change outs, more particulate matter is drawn through manifolds. Trap the particles with these fittings before they damage valve seats or pass into your recovery equipment. Replaceable, cleanable screens. 

UPC#	Description
41119	1/4" Manifold particulate filter
41120	3/8" Manifold particulate filter
41121	1/2" Manifold particulate filter
41122	Replacement filter screen (5 pak)

## SIGHT GLASS TOOL

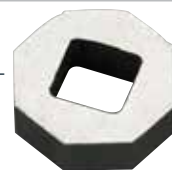
Designed to fit into the TITAN and BRUTE II sight-glass retainers, metal insert allows you to remove or tighten the retainer using a 1/4" drive wrench.



UPC#	Description
41095	Sight glass tool for TITAN/BRUTE 

## SINGLE GAUGE MANIFOLD

- Check pressure on lo-side of system
- Nylon seals and double "O" ring pistons

UPC#	Description
40318	Lo-side manifold R-12/22/502
40319	Lo-side manifold R-134a/404A/407C
40320	Lo-side manifold R-410A
40326	Lo-side 1/4" valve R-32/410A
40338	Lo-side manifold R-600A
40339	Hi-side manifold R-600A/600/290
40340	Lo-side manifold R-600A/600/290 



## SINGLE TEST GAUGES

Quick pressure checks - use lo- or hi-side gauge with quick coupler to attach directly to system or tanks. 



UPC#	Description
Gauge with quick coupler and 12" hose - angle coupling	
14811	12" Red hose 1/4" Male flare x 45° quick coupler
14821	12" Blue hose 1/4" Male flare x 45° quick coupler
19110	Quick coupler only
Gauge with 19110 quick coupler for recovery tank pressure checks	
40331	Red pressure °F
40332	Blue compound °F
40341	Red pressure w/quick coupler & hose
40342	Blue compound w/quick coupler & hose
19110	Quick coupler only
40334	Red pressure °F; 0 - 800 psi; R-22/404A/410A
40335	Blue compound °F; 0 - 800 psi; R-22/404A/410A
40344	Red pressure °F; 0 - 800 psi; R-22/404A/410A; with quick coupler and hose
40345	Blue compound °F; 0 - 800 psi; R-22/404A/410A; with quick coupler and hose

# SPECIALIZED AND GENERAL USE GAUGES







# Manifold Gauges

High visibility, colored temperature scales for accurate measurements.





# 3-1/8" (80 mm) DRY MANIFOLD GAUGES (°F and °C) RED, BLUE AND BLACK With 1% accuracy (Class 1) calibration

Large 3-1/8" gauges are housed in a red or blue steel case with front recalibrator screw. High visibility colored temperature scales are easy to read through the full view polycarbonate crystal.

- Flutterless™ technology with brass surge protector to minimize needle pulsation
- Brass gauge movement
- Copper alloy Bourdon tube
- 1/8" NPT Male connection
- Calibrated to 1% accuracy
- Color-coded red for pressure and blue for compound
- Color-coded refrigerant types

When a gauge has a **RETARD zone**, full scale is considered to be the last marked reading prior to entering the RETARD zone. For example, this gauge has a full scale reading of 120 psi. Gauge accuracy is not specified in the RETARD zone.



°F - Fahrenheit Gauges			
UPC#	Description	Pressure scale	Refrigerants
49103	3-1/8" Red pressure	0 - 500 psi	R-12/22/134a
49104	3-1/8" Blue compound	30"-0-120** psi	
49105	3-1/8" Red pressure	0 - 500 psi	R-22/134a/404A
49106	3-1/8" Blue compound	30"-0-120** psi	
49111	3-1/8" Red pressure	0 - 500 psi	R-417A/422A/422D
49112	3-1/8" Blue compound	30"-0-120** psi	
49133	3-1/8" Heat pump red dial	0 - 800 psi	R-22/407C/410A
49134	3-1/8" Heat pump blue dial	0 - 800 psi	
49137	3-1/8" Red pressure	0 - 800 psi	R-22/404A/410A
49138	3-1/8" Blue compound	30"-0-350*** psi	
49151	3-1/8" Red pressure	0 - 500 psi	R-134a/404A/407C
49152	3-1/8" Blue compound	30"-0-120** psi	
49157	3-1/8" Red pressure	0 - 800 psi	Pressure only
49158	3-1/8" Blue compound	0-55 bar	
49603	3-1/8" Red pressure	0 - 500 psi	R-448A/449A/452A
49604	3-1/8" Blue compound	30"-0-120** psi	
<b>Certified Gauges</b>			
49203	3-1/8" Red pressure	0 - 500 psi	R-12/22/134a
49204	3-1/8" Blue compound	30"-0-120** psi	
49205	3-1/8" Red pressure	0 - 500 psi	R-22/134a/404A
49206	3-1/8" Blue compound	30"-0-120** psi	
49237	3-1/8" Red pressure	0 - 800 psi	R-22/404A/410A
49238	3-1/8" Blue compound	30"-0-350*** psi	
49251	3-1/8" Red pressure	0 - 500 psi	R-134a/404A/407C
49252	3-1/8" Blue compound	30"-0-120** psi	

Universal Gauges (°F - Fahrenheit and °C - Celsius)			
UPC#	Description	Pressure scale	Refrigerants
49109	3-1/8" Red pressure	kPa and psi	R-32/410A
49110	3-1/8" Blue compound	kPa and psi	
49141	3-1/8" Heat pump red dial	0 - 800 psi	R-410A
49142	3-1/8" Heat pump blue dial	0 - 800 psi	
49155	3-1/8" Red pressure	bar, psi and kPa	R-32
49156	3-1/8" Blue compound	bar, psi and kPa	
49159	3-1/8" Red pressure	bar and psi	R-32/410A
49160	3-1/8" Blue compound	bar and psi	
49259	3-1/8" Red pressure	bar and psi	R-32/410A
49260	3-1/8" Blue compound	bar and psi	

°C - Celsius Gauges			
UPC#	Description	Pressure scale	Refrigerants
49107	3-1/8" Red pressure	kPa and psi	R-22/134a/404A
49108	3-1/8" Blue compound	kPa and psi	
49169	3-1/8" Red pressure	bar and psi	R-134a/404A/407C
49170	3-1/8" Blue compound	bar and psi	
49131	3-1/8" Red pressure	bar and psi	R-22/404A/410A
49132	3-1/8" Blue compound	bar and psi	
49139	3-1/8" Red pressure	psi	R-12/22/502
49140	3-1/8" Blue compound	psi	
49145	3-1/8" Red pressure	bar and psi	R-32/410A
49146	3-1/8" Blue compound	bar and psi	
49147	3-1/8" Red pressure	MPa	R-134a/404A/407C
49148	3-1/8" Blue compound	MPa	
49163	3-1/8" Red pressure	bar and MPa	R-12/134a/413A
49164	3-1/8" Blue compound	bar and MPa	
49165	3-1/8" Red pressure	bar and psi	R-134a/404A/407F
49166	3-1/8" Blue compound	bar and psi	
49181	3-1/8" Red pressure	bar and psi	R-448A/449A/452A
49182	3-1/8" Blue compound	bar and psi	
49601	3-1/8" Red pressure	0 - 500 psi	R-600a/600/290
49602	3-1/8" Blue compound	30"-0-120** psi	
49149	3-1/8" Red pressure	0 - 160 psi	R-134a/404A/407C
49150	3-1/8" Blue compound	30"-0-58* psi	
<b>Certified Gauges</b>			
49231	3-1/8" Red pressure	bar and psi	R-12/22/502
49232	3-1/8" Blue compound	bar and psi	
49245	3-1/8" Red pressure	bar and psi	R-134a/404A/407C
49246	3-1/8" Blue compound	bar and psi	
49263	3-1/8" Red pressure	bar and MPa	R-12/134a/413A
49264	3-1/8" Blue compound	bar and MPa	
49265	3-1/8" Red pressure	bar and psi	R-22/134a/404A
49266	3-1/8" Blue compound	bar and psi	
49269	3-1/8" Red pressure	bar and psi	R-22/134a/404A
49270	3-1/8" Blue compound	bar and psi	

\* Features retard protection to 101 psi.  
 \*\* Features retard protection to 350 psi.  
 \*\*\* Features retard protection to 500 psi.

Replacement Crystal - for 3 1/8" Gauges	
UPC#	Description
49100	Replacement crystal

## 3-1/2" (90 mm) LIQUID-FILLED MANIFOLD GAUGES (°F and °C) RED AND BLUE

With 1% accuracy (Class 1) calibration



Gauges are completely filled with glycerin for maximum protection from pulsation. Large 3-1/2" (90 mm) diameter gauge with refrigerants color-coded on the dials in bold numbers. Offset stem fits all major manifold brands.

- Now with zero adjustment
- 1/8" NPT Male connection
- Temperature rating of 0° to 122°F (-18° to 50°C)
- Calibrated to 1% accuracy (Class 1)



Universal Gauges (°F - Fahrenheit and °C - Celsius)			
UPC#	Description	Pressure scale	Refrigerants
49511	3-1/2" Red pressure	0-500 psi (0 to 34 bar)	R-22
49512	3-1/2" Blue compound	30"-0-120* psi (-1 to 8 bar)	
49519	3-1/2" Red pressure	0-800 psi (0 to 55 bar)	R-410A
49520	3-1/2" Blue compound	30"-0-300** psi (-1 to 21 bar)	
49193	3-1/2" Red pressure	0-3000 psi (0 to 210 bar)	R-744
49194	3-1/2" Blue compound	30"-0-1500 psi (-1 to 105 bar)	

°F - Fahrenheit Gauges			
UPC#	Description	Pressure scale	Refrigerants
49513	3-1/2" Red pressure	0-500 psi	R-22/134a/404A
49514	3-1/2" Blue compound	30"-0-120l psi	
49515	3-1/2" Red pressure	0-800 psi	R-22/410A
49516	3-1/2" Blue compound	30"-0-300** psi	
49517	3-1/2" Red pressure	0-500 psi	R-134a/404A/407C
49518	3-1/2" Blue compound	30"-0-120* psi	

°C - Celsius Gauges			
UPC#	Description	Pressure scale	Refrigerants
49521	3-1/2" Red pressure	0-500 psi (0 to 35 bar)	R-134a/404A/407C
49522	3-1/2" Blue compound	30"-0-116* psi (-1 to 8 bar)	

\*Features retard protection to 350 psi.  
\*\*Features retard protection to 500 psi.

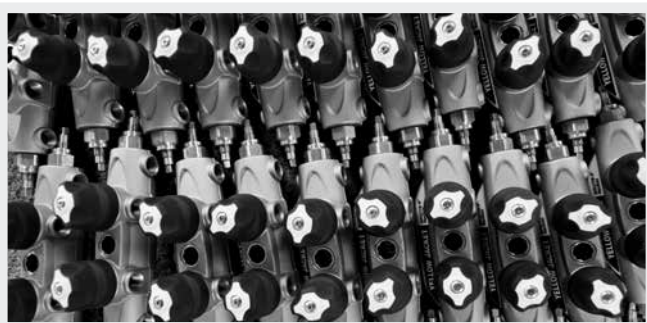

## 2-1/2" (68 mm) MANIFOLD GAUGES (°F and °C) RED AND BLUE Class B



- Steel case with 3-2-3% accuracy
- High-visibility dials - colored temperature scales for easy reading;
- Flutterless™ technology surge protector minimizes the needle pulsation for improved accuracy
- 1/8" NPT Male connection

### Universal Gauges (°F - Fahrenheit and °C - Celsius)

UPC#	Description	Pressure scale	Refrigerants
49013	2-1/2" Red pressure	0 - 500 psi	R-134a
49014	2-1/2" Blue compound	30"-0-120** psi	
49035	2-1/2" Red pressure	0 - 800 psi/kg/cm <sup>2</sup>	R-410A
49036	2-1/2" Blue compound	30"-0-300*** psi/kg/cm <sup>2</sup>	
49053	2-1/2" Red pressure	0 - 55 bar (0-5.5 MPa)	R-410A
49054	2-1/2" Blue compound	-1 - 21 bar* (-0.1 - 2.1 MPa)	

### °F - Fahrenheit Gauges

UPC#	Description	Pressure scale	Refrigerants
49001	2-1/2" Red pressure	0 - 500 psi	R-12/22/502
49002	2-1/2" Blue compound	30"-0-120** psi	
49015	2-1/2" Red pressure	0 - 500 psi	R-22/134a/404A
49016	2-1/2" Blue compound	30"-0-120** psi	
49051	2-1/2" Red pressure	0 - 500 psi	R-134a/404A/507
49052	2-1/2" Blue compound	30"-0-120** psi	

### °C - Celsius Gauges

UPC#	Description	Pressure scale	Refrigerants
49027	2-1/2" Red pressure	kg/cm <sup>2</sup> and psi	R-12/22/502
49028	2-1/2" Blue compound	kg/cm <sup>2</sup> and psi	
49031	2-1/2" Red pressure	bar and psi	R-22/134a/407C
49032	2-1/2" Blue compound	bar and psi	
49033	2-1/2" Red pressure	bar and psi	R-22/134a/404A
49034	2-1/2" Blue compound	bar and psi	
49055	2-1/2" Red pressure	bar and psi	R-134a/404A/507
49056	2-1/2" Blue compound	bar and psi	
49057	2-1/2" Red pressure	kg/cm <sup>2</sup> and psi	R-134a/404A/507
49058	2-1/2" Blue compound	kg/cm <sup>2</sup> and psi	
49063	2-1/2" Red pressure	bar and psi	R-134a/404A/407C
49064	2-1/2" Blue compound	bar and psi	

\* Features retard protection to 35 bar  
\*\* Features retard protection to 350 psi.  
\*\*\* Features retard protection to 500 psi.  
Note: Small screw in back is 6/32" x 5/32" Phillips pan head screw.  
Note: Gauges not meant to be used with nitrogen.

### Replacement Crystal - for 2 1/2" Gauges

UPC#	Description
49010	Replacement crystal

## DIGITAL MANIFOLD GAUGE (°F and °C) For Series 41 Digital Manifold

3-1/8" backlit LCD gauges provide easy-to-read accurate measurements for system pressures. This gauge is capable of handling maximum pressures of 800 psi, so there are no worries about over-pressurizing. The YELLOW JACKET Digital gauges provide clear, swift and accurate pressure measurements for all your system applications. Pre-programmed with 21 of the most common refrigerants.

### Refrigerants

R-22, R-23, R-32, R-124, R-134A, R-290, R-404A, R-407C, R-407F, R-408A, R-410A, R-417A, R-427A, R-444B, R-448A, R-449A, R-452A, R-507, R-600A, R-1234YF, R1270

UPC#	Description
49017	Series 41 digital manifold

### Gauge Specifications

- Pressure Range: -14.7 ~ 800 psi (-1 ~ 54.4 bar)
- Unit (Pressure): psi / bar / MPa / kg/cm2 / kPa
- Working Temperature: 14°F ~ 140°F (-10°C ~ 60°C)
- Pressure Accuracy: ±0.5% F.S @71.6~82.4°F (@22~28°C)
- Unit (Temperature): °F/°C
- Working Humidity: 35~85%
- Sampling Rate = 1.2 sec max.
- Auto-off: 10 minutes
- Zero pressure function
- Power Supply: Battery CR123A (3.0V, 1400mAh)
- Battery Life: 2 years for continuous operation without backlight
- Warranty: One year



## HEAVY DUTY 2-1/2" BRASS MANIFOLD GAUGES (°F and °C) With 1% accuracy (Class 1) calibration



Solid brass case and premium movements. Heavy duty phosphor bronze and stainless steel internal components for longer service life under severe use.  **MADE IN THE USA**

- Flutterless™ technology with brass surge protector to minimize needle pulsation
- 1/8" NPT Male connection
- Calibrated to 1% accuracy
- Full view glass crystal

UPC#	Description	Pressure scale	Refrigerants
49067	°F Brass pressure	0 - 500 psi	R-22/134a/404A
49068	°F Brass compound	30"-0-120" psi	
<b>Certified Gauges</b>			
49199	2-1/2" Brass pressure	0 - 500 psi	R-22/134a/404A
49200	2-1/2" Brass compound	30"-0-120" psi	
49010	Replacement crystal (polycarbonate) for old 49011, 49012		
49039	Glass crystal for brass gauge		
49040	Brass gauge ring		

\*Features retard protection to 350 psi.  
Note: Gauges are not meant to be used with nitrogen.

## PROTECTIVE GAUGE BOOTS For 2-1/2" (63.5 mm), 3-1/8" (80 mm)



Rubber boots slip easily around gauges to cushion and protect them from impact.

- Fit 2-1/2" and 3-1/8" gauges without covering easy access recalibration screw
- Color-coded red or blue to match gauge
- Made in the USA 

UPC#	Description
49010	2-1/2" Polycarbonate Lens
49090	2-1/2" Set of gauge boots
49091	2-1/2" Red protective gauge boot
49092	2-1/2" Blue protective gauge boot
49100	3-1/8" Replacement Crystal
49190	3-1/8" Set of gauge boots
49191	3-1/8" Red protective gauge boot
49192	3-1/8" Blue protective gauge boot





## 3-1/8" MECHANICAL VACUUM GAUGES



Full range mechanical Bourdon tube steel gauges for determining system vacuum is more accurate than a compound gauge. All gauges are 1/8" NPT Male bottom connection.

- Larger to show vacuum more accurately in inches of mercury and Torr (or millibar)

**CAUTION:** Vacuum gauges must be handled carefully. Dropping, pressurizing and rough handling reduce their life.

UPC#	Size	Scale	Connection	Case
69044	3-1/8"	0-30" Hg & 760-0 Torr	1/8" NPT Male lower	Green
69045	3-1/8"	1000-0 millibar & 30-0" (Euro)	1/8" NPT Male lower	Green
49100	3-1/8"	Replacement crystal		

## LOW PRESSURE DIAPHRAGM 2-1/2" GAUGES



- The bronze diaphragm is designed for better protection on incidental overpressure
- Intended for low pressure applications only
- Black steel case
- Cannot be recalibrated

UPC#	Description	Range
78056	2-1/2" Barb type connection	0-10" W.C.
78061	2-1/2" Barb type connection	0-35" W.C.
78057	2-1/2" 1/4" NPT Male connection	0-10" W.C.
78066	2-1/2" 1/4" NPT Male connection	0-35" W.C.

## 2-1/2" AMMONIA GAUGES With dual scale



Ammonia gauges are designed for use on manifolds and as permanent gauges on any system or equipment charged with ammonia. The Bourdon tube is made of 316 stainless. The dials show dual temperature and pressure scales. All gauges are equipped with restrictors to protect the gauges against pulsating pressure.

- 1/4" NPT Male connection
- Black steel gauges
- Steel sockets
- Calibrated to 3-2-3% accuracy

UPC #	Description	Range
40201	2-1/2" Gauge with twist on polycarbonate crystal	30" - 0 - 400 psi °F and -0.1-0-28 bar °C
40202	2-1/2" Gauge with twist on polycarbonate crystal	30" - 0 - 150 psi °F and -0.1-0-10 bar °C
49010	2-1/2" Replacement crystal	

# REFRIGERANT RECOVERY SYSTEMS



CHARGING  
SYSTEMS

GAUGES

RECOVERY  
MACHINES

VACUUM PUMP  
SYSTEMS

VACUUM AND  
CHARGING HOSES

HOSE ADAPTERS,  
VALVES & PARTS

WIRELESS AND  
ELECTRONIC  
INSTRUMENTS

LEAK DETECTORS  
AND MONITORS

HEATING  
INSTRUMENTS

SYSTEM TOOLS





## Refrigerant Recovery Machines

Built in purge circuit eliminates the need for external equipment and makes for easy clearing at the end of the job.

Superior condenser performance means the recovery tank stays cooler for a longer period of time, allowing you to recover more refrigerant without high-pressure cut-out.





Don't let the small size fool you. The YJ-LTE™ Refrigerant Recovery System is packed with the features you need at a price your budget can handle. Like a built in purge circuit which eliminates the need for external equipment and makes for easy clearing at the end of the job. And superior condenser performance which means the recovery tank stays cooler for a longer period of time, allowing you to recover more refrigerant without high-pressure cut-out. And it's simple to operate, too, with a single valve, single gauge control panel.

**Additional Features:**

- ½ hp, twin cylinder, oil-less compressor for fast recovery of Class III, IV and V refrigerants including R-410A
- Superior condenser design and performance:
  - System designed for high load conditions
  - Keeps tank up to 10° cooler
  - Allows gravity flow of recovered liquid to recovery tank
- Easy-to-read and extremely durable 2-1/2" liquid-filled condenser pressure gauge
  - Virtually no flutter under any condition
  - Protects against damage from pressure pulses
- Single valve control panel
  - Simple operation
  - Position for either recovery or purge
- Single gauge shows tank pressure during recovery and recovery unit internal pressure during purge
- Sealed compressor crankcase to minimize refrigerant loss over the life of the compressor
- Built-in purge circuit for easy clearing at the end of each job; no extra tanks or vacuum pumps required
- Cup-style piston seals for better performance under high pressure differentials
- Quiet running compressor performance
- Lightweight at 24 pounds
- One-year warranty

**Specifications:**

Capabilities:	Vapor, liquid, push/pull
Refrigerants:	12, 22, 134a, 407C, 410A, 500, 502, and other Class III, IV and V refrigerants
Compressor:	½ hp, twin cylinder, reciprocating, oil-less
Power Source:	115V/60 Hz (95730 and 95732) 230V/50 Hz (95733 and 95738)
Amps:	8.0 (95730 and 95732) 4.0 (95733 and 95738)
High Pressure Shut-Off:	517 psi – auto reset
Operating Temperature:	40° to 122° F (4° to 50° C)
Approvals:	Performance tested by UL to ARI 740-98 (95732 - CSA C22.2 No. 120) 24 Lbs.
Weight:	24 Lbs.
Dimensions:	9.0 (w) x 11.5 (h) x 13.5 (d) in. 22.86 (w) x 29.21 (h) x 34.29 (d) cm

**YJ-LTE RECOVERY RATINGS**

(UL* ARI - 740-98) Vacuum Level: 15 inHg								
	Lbs./min.				Kg./min.			
	Vapor	Push/Pull	Liquid	High Temp Vapor	Vapor	Push/Pull	Liquid	High Temp Vapor
R-22	0.37	9.17	6.83	0.28	0.17	4.16	3.10	0.13
R-407C	0.30	10.05	7.53	N/A	0.14	4.56	3.42	N/A
R-410A	0.35	10.91	9.27	N/A	0.16	4.95	4.20	N/A

\* UL and ARI tests are only one way to evaluate recovery speed, and rates are a "level field" comparison method. In other testing conditions, units can exhibit much higher rates.

**Built-In High Side Pressure Gauge**

- 2-1/2" Liquid-filled pressure gauge shows discharge pressure during recovery and internal pressure during purge.
- 0 - 40 bar; 0 - 600 psi helps you monitor recovery.
- Durable and easy to read under any conditions.



**Direct Drive Fan**

- No gears, fewer parts, more reliable air flow
- No overheating and melting parts
- Cools the condenser first to help keep the recovery tank pressure lower

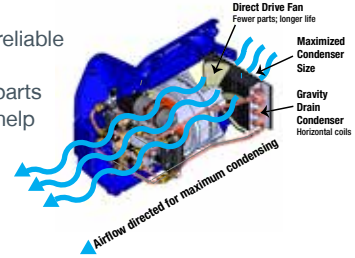

**Built-In PurgeCircuit**



- Changeover from liquid to vapor to purge
- No external equipment required
- Simple to use - move the hose and turn the selector button

**Built-In Condenser**

- 24 in<sup>2</sup> (5/16" tubes) with gravity drain
- Reliable operation in high ambient conditions

**Built-In Circuit Breaker**

- Prevents tripping of building circuit breakers

**Displacement**

- Largest displacement among lightweight recovery machines - 11.5 cc (.7 C.I.)

**Motor Speed**

- Powerful 4 pole 1725 RPM CSIR motor



95732, 95733, 95738

UPC#	Description
95730	YJ-LTE Refrigerant Recovery System
95732	YJ-LTE CSA Refrigerant Recovery System
95733	YJ-LTE 230V/50-60 Hz (Euro and UK plug)
95738	YJ-LTE™ 230V/50-60 Hz (AU/NZ plug)
95560	1/4" M x F Filter Fitting



CHARGING SYSTEMS  
 GAUGES  
 RECOVERY MACHINES  
 VACUUM PUMP SYSTEMS  
 VACUUM AND CHARGING HOSES  
 HOSE ADAPTERS, VALVES & PARTS  
 WIRELESS AND ELECTRONIC INSTRUMENTS  
 LEAK DETECTORS AND MONITORS  
 HEATING INSTRUMENTS  
 SYSTEM TOOLS

## RecoverXLT® REFRIGERANT RECOVERY MACHINE



Fully automatic operation for fast recovery of Class III, IV and V refrigerants including R-410A, backed by the best warranty in the industry.



Turn the single control valve to “liquid” or “vapor” settings, and the machine will complete recovery while you work on other aspects of the job.

Convenient cord storage

- Single valve control for easy changeover from liquid to vapor to purge
- Advanced 1/2 hp, 1750 rpm oil-less twin cylinder compressor with precision valves manufactured in an ISO-9001 facility
- Recovers refrigerant and shuts off when unit reaches 15" of vacuum. Unit will automatically restart if system pressure rises
- Indicator signals “recovery complete”
- Quiet running with components nested to reduce vibration and noise. Oil-less compressor is inherently quiet
- Controls and gauges inset for protection and angled for easy access and viewing
- Senses back pressure from tank and shuts off automatically at 517 psi for safety

- Reusable mesh particulate filter inserts into suction port for protection. Simple cleaning eliminates replacement due to clogging
- “On-the-fly” purge with simple turn of a knob to remove residual refrigerant and help prevent cross-contamination
- High efficiency fan keeps air moving across condenser for cool running even in hot weather
- High strength HDPE case for lightweight and rugged use. Rounded corners help protect from nicks and scrapes
- Single high pressure safety switch - external circuit breaker
- Includes three-year compressor warranty
- Made in the USA 
- Tested by UL to ARI 740-98

UPC#	Description
95760	RecoverXLT 115V/60 Hz
95762	RecoverXLT with tank overfill switch 115/60 Hz
95765	RecoverXLT 110V/50 Hz (IEC 60309 plug)

## RecoverXLT2-AP™ REFRIGERANT RECOVERY MACHINE

The drive to lower global warming potential refrigerants with increased flammability has necessitated the evolution of the market leading YELLOW JACKET® RecoverXLT™ recovery machine: The new RecoverXLT2-AP™ Refrigerant Recovery Machine with twin cylinder 1/2 hp oil less compressor and gravity drain condenser. The unique “ambient pressure switch” and three meter power cord comply with the current safety requirements. The RecoverXLT2-AP is specifically designed for the new lower GWP refrigerants including R-32, R-1234yf and R1234ze as well as the most common CFC, HFC and HFO refrigerants, including R-22, R-404A, R-407, R-410A, R-448A and R-449A.



- 1/2 hp, twin cylinder, oil-less compressor for fast recovery of Class III, IV and V refrigerants including R-32, R-1234yf and R-1234ze.
- Safe venting of case interior prior to start up.
- Low pressure switch stops recovery above ambient pressure for leaking systems to prevent pulling air into recovery cylinders.
- Low pressure bypass for recovery of leak-free systems.



UPC#	Description
95764	RecoverXLT2-AP Refrigerant Recovery System 230V/50-60 Hz (Euro, UK, NZ and Australian plug)*

\*Not tested and approved for use in the U.S.A.

# RECOVERY MACHINE COMPARISON CHART

Features	RecoverXLT #95760/95762	RecoverXLT2-AP #95764**	RecoverXLT #95765
Recovery capabilities	Vapor, liquid, push/pull	Vapor, liquid, push/pull	Vapor, liquid, push/pull
Compressor	1/2 hp oil-less	1/2 hp oil-less	1/2 hp oil-less
Weight	32.6 lbs. (14.78 kg)	32.6 lbs. (14.78 kg)	32.6 lbs. (14.78 kg)
Size L x W x H inches Size L x W x H mm.	19.3 x 12.4 x 12.5 490 x 315 x 317	19.3 x 12.4 x 12.5 490 x 315 x 317	19.3 x 12.4 x 12.5 490 x 315 x 317
Refrigerant compatibility	12, 22, 134a, 407C, 410A, 500, 502, HP, MP and blends	32, 1234yf, 1234ze, 22, 404A, 407, 410A, 448A, 449A and more	12, 22, 134a, 407C, 410A, 500, 502, HP, MP and blends
Volts/Hertz	115V/60 Hz	230V/50-60 Hz	110V/50 Hz
Tank overflow sensor	95760 No / 95762 Yes	No	No
Low pressure shut-off sensor	Standard	Standard	No
Inlet mesh filter screen	Included	Included	Included
Inlet filter dryer	Optional filter available for use on contaminated and burn-out systems; use a filter of adequate size (P/N 95014).		
Suction and discharge pressure gauges	Standard	Standard	Standard
Upgraded higher suction and discharge pressure gauges	Standard	Standard	Standard
Upgraded single higher pressure switch	Standard	Standard	Standard
External circuit breaker	Standard	Standard	Standard
Plug	U.S.	Euro, UK, AU and NZ	IEC 60309
Warranty	1 year parts and labor; 3 years compressor	1 year	1 year parts and labor; 3 years compressor
Certified to ARI standard	ARI 740-98		
Testing agency	UL	UL	UL
CUL listed	Yes	No	No
CE marked	No	Yes	Yes
<b>Applicable ARI standard</b>	<b>740-98</b>	<b>740-98</b>	<b>740-95</b>
<b>Recovery rating in lbs./min.</b>	<b>Vapor Push/Pull Liquid</b>	<b>Vapor Push/Pull Liquid</b>	<b>Vapor Push/Pull Liquid</b>
R-12	0.33 13.49 1.98	0.22 8.99 1.32	0.22 8.99 1.32
R-22	0.33 13.49 1.98	0.22 8.99 1.32	0.22 8.99 1.32
R-134a	0.33 13.49 1.98	0.22 8.99 1.32	0.22 8.99 1.32
R-410A	0.48 12.21 1.68	0.32 8.14 1.12	N/A N/A N/A
R-500	0.33 13.49 1.98	0.22 8.99 1.32	0.22 8.99 1.32
R-502	0.59 13.58 2.65	0.39 9.05 1.77	0.39 9.05 1.77
<b>Recovery rating in kg./hr.*</b>	<b>Vapor Push/Pull Liquid</b>	<b>Vapor Push/Pull Liquid</b>	<b>Vapor Push/Pull Liquid</b>
R-12	9.00 367.20 54.00	6.00 244.80 36.00	6.00 244.80 36.00
R-22	9.00 367.20 54.00	6.00 244.80 36.00	6.00 244.80 36.00
R-134a	9.00 367.20 54.00	6.00 244.80 36.00	6.00 244.80 36.00
R-410A	13.20 332.40 45.60	8.80 221.60 30.40	N/A N/A N/A
R-500	9.00 367.20 54.00	6.00 244.80 36.00	6.00 244.80 36.00
R-502	16.20 369.70 72.00	10.80 246.40 48.00	10.80 246.40 48.00

\*ARI tests are only one way to evaluate recovery speed. In other testing conditions the units can exhibit much higher performance rates. ARI rates are a "level field" comparison method.

\*\*Rates do not include 95764. Calculated recovery ratings for this product can be found at [www.yellowjacket.com](http://www.yellowjacket.com)

CHARGING SYSTEMS  
GAUGES  
RECOVERY MACHINES  
VACUUM PUMP SYSTEMS  
VACUUM AND CHARGING HOSES  
HOSE ADAPTERS, VALVES & PARTS  
WIRELESS AND ELECTRONIC INSTRUMENTS  
LEAK DETECTORS AND MONITORS  
HEATING INSTRUMENTS  
SYSTEM TOOLS



CHARGING SYSTEMS  
GAUGES  
RECOVERY MACHINES  
VACUUM PUMP SYSTEMS  
VACUUM AND CHARGING HOSES  
HOSE ADAPTERS, VALVES & PARTS  
WIRELESS AND ELECTRONIC INSTRUMENTS  
LEAK DETECTORS AND MONITORS  
HEATING INSTRUMENTS  
SYSTEM TOOLS

## PARTS FOR R 50A, R 60A, R 70A, R 100



Mesh particulate filter for YELLOW JACKET® recovery machines remove particles to protect units. Easy to clean and reuse or replace.



UPC#	Description
95134	Screens R 70a Series (4 pak)
95136	Screens R 80a, R 100 Series (4 pak)
95139	Screens R 60 and R 60a Series (4 pak)
95141	Screens RST (4 pak)
95342	Replacement brass bulkhead fitting for R 60a and R 70a
95343	Replacement "O" ring for R 60a and R 70a (3 pak)
95538	R 60 solid state TOS board

## WRAP-AROUND HEATER FOR REFRIGERANT CYLINDER

- Fits 30, 50 and 125 lb. cylinders
- Thermostat controlled with maximum 130°F (54°C) and minimum 120°F (48.8°C) (surface temperature of tank)
- Cycles on/off to maintain surface temperature
- 200 watt, 115V or 230V
- 20" velcro straps and 6' cord



UPC#	Description
68848	Wrap-around cylinder heater 115V
68849	Wrap-around cylinder heater 230V

## SIGHT GLASS



Use with YELLOW JACKET® RecoverX and RecoverXLT machines. Indicates when all liquid has been recovered so you can switch immediately to vapor cycle and speed up the recovery process. 1/4" flare x 1/4" female flare.



UPC#	Description
41145	Sight glass with 1/4" connections

## THE TRAP SEPARATOR

High porosity filter effectively traps sealant, dye and lubricant so only pure refrigerant exits to your recovery equipment. Filter replacement is easy in less than five minutes.



UPC#	Description
38087	The Trap Separator – 1/4" flare fittings
38081	Replacement filter pak

## REFRIGERANT RECOVERY CYLINDERS FOR R-410A

These gray and yellow 30 and 50 lb. cylinders feature "Y" valve for liquid/vapor, 400 psi rating and 3/4" plug for a float switch.



UPC#	Description
95002	30 lb. 400 psi cylinder DOT 400
95007	50 lb. 400 psi cylinder DOT 400
95012	30 lb. 400 psi cylinder DOT 400 with float switch
95013	50 lb. 400 psi cylinder DOT 400 with float switch

## RECOVERY BURNOUT FILTER FOR DIRTY SYSTEMS

UPC#	Description
95014	Recovery filter

High capacity in-line filter drier removes moisture and oil breakdown products, as well as acid from burnt out systems. Attaches directly to refrigerant recovery system with a 1/4" female and a 1/4" male connection. UL and CSA listed.



## PARTS FOR RECOVERX AND RECOVERXLT

UPC#	Description
95156	Circuit breaker (12 AMP)
95190	Capacitor (115V Machine)
95187	Relay (115V Machine)
95188	Shorting cap for umbilical cord
95210	Large cord strain relief bushing
95215	Power cord (U.S.)
95216	Rocker switch
95248	Umbilical cord overflow sensor
95294	Fan clip
95325	High pressure switch
95338	Low pressure switch
95444	Case, front
95445	Case, rear
95446	Case, half (both halves)
95447	Case, cord wrap
95448	Aluminum frame
95449	Compressor bracket grommet (5 pk)
95450	Condensor coil
95451	High pressure gauge
95452	Low pressure gauge
95453	Manifold assembly
95456	Neon lamp (115V Machine)
95528	CPR valve
95455	Fan blade
95457	Replacement filter screen
95477	TOS LED strip assembly
95527	Solid state TOS board
95538	R 60 solid state TOS board

# VACUUM PUMP SYSTEMS



CHARGING SYSTEMS

GAUGES

RECOVERY MACHINES

VACUUM PUMP SYSTEMS

VACUUM AND CHARGING HOSES

HOSE ADAPTERS, VALVES & PARTS

WIRELESS AND ELECTRONIC INSTRUMENTS

LEAK DETECTORS AND MONITORS

HEATING INSTRUMENTS

SYSTEM TOOLS





## Vacuum Pumps

Select from a complete line of Vacuum Pumps that meet your needs.





## SUPEREVAC™ VACUUM PUMPS 4, 6, 8, 11 cfm



### Enhancements to Improve Performance and Ergonomics:

- Convenient shoulder strap for easy carrying over long distances with built-in mount points.
- Smaller oil bath requires half as much oil as previous design
- Built-in cooling fins to cool pump and increase performance
- Oil suck-back valve improvement
- Elongated oil sight glass – easier to see oil level
- Tethered oil drain plug

The SUPEREVAC™ vacuum pump is a highly efficient, two-stage rotary vane oil-sealed pump field-rated at 15 microns or better.

### Features & Benefits

- Isolation valve for oil changes without losing vacuum in the system
- Gas ballast valve keeps oil cleaner, longer during evacuation of wet system
- Internal intake check valve to help prevent oil backup into the system during a power failure
- Intake filter screen keeps damaging particles from entering the pump
- Heavy duty rotors and bearings
- Built-in vacuum gauge
- Wide mouth oil reservoir port for easier, cleaner filling. Doubles as a pump exhaust – threaded to attach a garden hose for exhausting to a remote location.
- Large brass oil drain for easy access to fast oil changes
- Downward angled oil pump to remove contaminants usually trapped in other sump designs.
- Heavy duty steel handle
- Lift hook for hoisting pump to rooftops
- Two-year warranty
- Made in the USA 

Domestic	Model 93540	Model 93560	Model 93580	Model 93590
Free air displacement	4.0 cfm	6.0 cfm	8.0 cfm	11.0 cfm
Number of stages	2-stage rotary vane	2-stage rotary vane	2-stage rotary vane	2-stage rotary vane
Field blankoff	15 microns	15 microns	15 microns	15 microns
Intake	1/4" and two 3/8" Male flares	1/4" and two 3/8" Male flares	1/2", 3/8", 1/4" Male flares	1/2", 3/8", 1/4" Male flares
Motor	1/2 hp - 1725 rpm	1/2 hp - 1725 rpm	1/2 hp - 1725 rpm	1/2 hp - 1725 rpm
Thermal overload protection	Yes	Yes	Yes	Yes
Voltage (single phase)	115V/60 Hz	115V/60 Hz	115V/60 Hz	115V/60 Hz
Power cord	6' - motor mounted switch	6' - motor mounted switch	6' - motor mounted switch	6' - motor mounted switch
Oil capacity	36 oz.	36 oz.	28 oz.	28 oz.
Dimensions	16" L x 6" W x 11.5" H (40.6 cm X 15.2 cm X 29.2 cm)	16" L x 6" W x 11.5" H (40.6 cm X 15.2 cm X 29.2 cm)	17.5" L x 6" W x 11.5" H (44.5 cm X 15.2 cm X 29.2 cm)	17.5" L x 6" W x 11.5" H (44.5 cm X 15.2 cm X 29.2 cm)
Net weight	30.3 lbs. (13.7 kg)	31.2 lbs. (14.2 kg)	32.5 lbs. (14.8 kg)	34.1 lbs. (15.4 kg)
Export	Model 9354x	Model 9356x	Model 9358x	Model 9359x
Free air displacement	113/95 L/M	170/142 L/M	225/190 L/M	310/260 L/M
Motor	1/2 hp - 1725/1425 rpm	1/2 hp - 1725/1425 rpm	1/2 hp - 1725/1425 rpm	1/2 hp - 1725/1425 rpm
Motor voltage (dual phase)	115/230V / 50-60 Hz	115/230V / 50-60 Hz	115/230V / 50-60 Hz	115/230V / 50-60 Hz
Dimensions	16.75" L x 6" W x 11.5" H (42.5 cm X 15.2 cm X 29.2 cm)	16.75" L x 6" W x 11.5" H (42.5 cm X 15.2 cm X 29.2 cm)	18.25" L x 6" W x 11.5" H (46.4 cm X 15.2 cm X 29.2 cm)	18.25" L x 6" W x 11.5" H (46.4 cm X 15.2 cm X 29.2 cm)
Net weight	33.2 lbs. (15.1 kg)	33.9 lbs. (15.4 kg)	35.5 lbs. (16.1 kg)	37.0 lbs. (16.8 kg)
<b>Model #</b>	<b>93542</b> (95 L/M at 50 Hz) (113 L/M at 60 Hz)	<b>93562</b> (142 L/M at 50 Hz) (170 L/M at 60 Hz)	<b>93582</b> (190 L/M at 50 Hz) (225 L/M at 60 Hz)	<b>93592</b> (260 L/M at 50 Hz) (310 L/M at 60 Hz)
US plug	230V	230V	230V	230V
Factory voltage setting				
<b>Model # Euro plug</b>	<b>93543</b> (95 L/M at 50 Hz)	<b>93563</b> (142 L/M at 50 Hz)	<b>93583</b> (190 L/M at 50 Hz)	<b>93593</b> (260 L/M at 50 Hz)
Factory voltage setting	230V	230V	230V	230V (EU/UK plug)
<b>Model # AU/NZ plug</b>	<b>93544</b> (95 L/M at 50 Hz) (113 L/M at 60 Hz)	<b>93564</b> (142 L/M at 50 Hz) (170 L/M at 60 Hz)	<b>93584</b> (190 L/M at 50 Hz) (225 L/M at 60 Hz)	
Factory voltage setting	230V	230V	230V	
<b>Model # UK Plug</b>	<b>93547</b> (95 L/M at 50 Hz)	<b>93567</b> (142 L/M at 50 Hz)	<b>93587</b> (190 L/M at 50 Hz)	
Factory voltage setting	230V	230V	230V	

All parts listed will not work with NHs.

For replacement parts, refer to the manual (also available at [yellowjacket.com](http://yellowjacket.com))

## BULLET® VACUUM PUMPS



Domestic	Model 93600	
Free air displacement	7.0 cfm	
Number of stages	2-stage rotary vane	
Field blankoff	25 microns	
Intake	1/4" x 3/8" x 3/8"	
Motor	1/2 hp - 1725 rpm	
Thermal overload protection	Yes	
Voltage (single phase)	115V/60 Hz	
Power cord	6' - motor mounted switch - U.S. plug	
Oil capacity	28 oz. (0.828 L)	
Dimensions	16.25" L x 6.25" W x 8.25" H (41.3 cm x 15.9 cm x 21 cm)	
Net weight	31.6 lbs. (14.3 kg)	
Export	EU/UK 93610; AU/NZ 93620	
Detachable IEC Cord type	EU/UK	AU/NZ
Free air displacement	200/165 L/M	
Motor	CE 1/2 hp - 1725/1425 rpm	
Voltage (dual phase)	115/230V / 50-60 Hz	
Dimensions	17" L x 6.25" W x 8.25" H (43.2 cm x 15.9 cm x 21 cm)	
Net weight	34.5 lbs (15.7 kg)	

The BULLET® pulls down to 25 microns or better, protecting from contaminants and non-condensable gasses in the HVAC system, which can damage components, reduce efficiency and cause system failure.

- Wide mouth oil reservoir port for easier, cleaner filling. Doubles as pump exhaust; threaded to attach garden hose for exhausting to remote location
- Large oil sight glass for easy monitoring of oil level
- Large brass oil drain for easy access to fast oil changes
- Internal intake check valve to help prevent oil backup into the system during a power failure
- Heavy-duty rotors and bearings
- Intake filter screen keeps damaging particles from entering the pump
- Heavy-duty steel handle for well-balanced carrying
- Tethered port caps stay with the pump
- Stable base; wide-stance metal with rubber overlay
- Two year warranty
- Made in the USA 

For replacement parts, refer to the manual (also available at [yellowjacket.com](http://yellowjacket.com))

## HOW TO MEASURE AN "ADEQUATE" VACUUM

Many contractors pull the refrigerant out and think the work is done. In reality, when you get to 29 inches of vacuum (the green zone on your gauge), you are only half finished. Once the recovery machine has done its work, it's time to finish off the job with a vacuum pump.

### Standard Lo-Side Gauge

Shows vacuum in inches. A  $\pm 1\%$  gauge would be accurate to  $\pm 7600$  microns when calibrated at a full vacuum (which is generally not the case with this type of gauge).

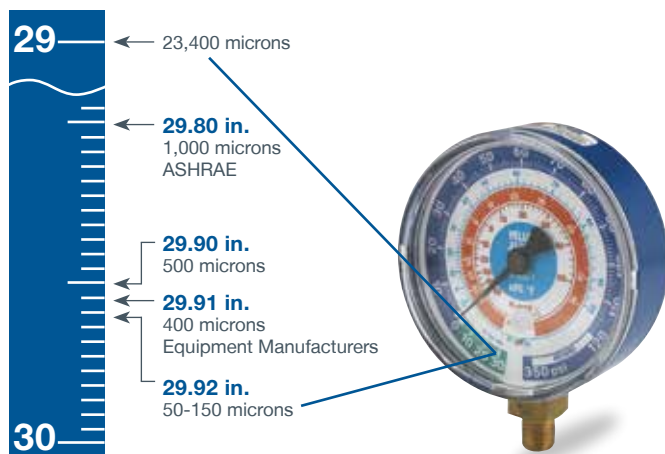

Only an electronic vacuum gauge can precisely measure the level at which non-condensable gas is removed from system.

### Why a Vacuum Pump?

ASHRAE recommends evacuation to below 1000 microns for moisture removal and below 500 microns after replacing a compressor. Some equipment manufacturers call for evacuation to 400 microns to ensure that harmful water vapor is removed from the system.

When you have water vapor in your system, the risk of icing up capillary tubing and expansion valves becomes much higher. A high quality vacuum pump will be able to take you down to 200-500 microns. With the system almost completely free from water vapor, you are ready to put the refrigerant back in the system. A thorough approach to evacuation ensures longer equipment life and reduced risk of problems.

### Use a Vacuum Gauge to Read Vacuum Down to 25 Microns

1000 microns equal only 0.039 inches of mercury, a measurement that cannot be made with a mechanical gauge, or determined by evacuation time or the sound of the pump. A popular tool that can measure vacuum at evacuation levels below 1000 microns is an electronic vacuum gauge.

The best place to measure vacuum is at the system, not at the pump. With a combination vacuum/charging valve, you can attach the electronic vacuum gauge directly to the system and isolate it from the pump, hoses and manifold for a true indication of the vacuum in the system. With a digital vacuum gauge, you can see the last evidence of moisture being removed and witness that the system has been dried out.

## YJII® VACUUM PUMPS



YJII® is a compact, lightweight, portable and affordable pump for servicing small systems.

- Deep ultimate vacuum
- Quick flow rate
- Wide range of applications
- Lightweight, durable aluminum housing
- Small and portable
- Reliable – runs steadily for long periods
- Thermal protector in motor to guarantee pump runs steadily and safely
- High torque motor design for easy start-up and efficient operation, even in the harshest conditions
- 1/4" and 3/8" SAE flare inlet connections allow for flexibility of hose fittings/sizes
- 3/4" garden hose exhaust fitting with removable cap for venting
- Oversized 3/8" oil drain for faster oil changes
- Vacuum pump oil included
- One year warranty

SPECIFICATIONS	93266	93265 INTL
Free Air Displacement	5 cfm	4 cfm 95 L/M
Ultimate Vacuum	25 microns	25 microns
Number of Stages	2 Stage	2 Stage
Motor	1/2 hp - 1725 rpm	1/2 hp - 3000 rpm
Intake Ports	1/4" and 3/8" SAE	1/4" and 3/8" SAE
Voltage (single phase)	120V (50-60 Hz)	220-240V (50-60 Hz)
Oil Capacity	18 oz (532 ml)	532 ml
Dimensions	13" x 5" x 11"	330 mm x 127 mm x 279 mm
Weight	25.3 lbs (11.5 kg)	10.9 kg

UPC#	Description
93266	YJII® Vacuum Pump 5cfm
93265	YJII® Vacuum Pump 4cfm INTL

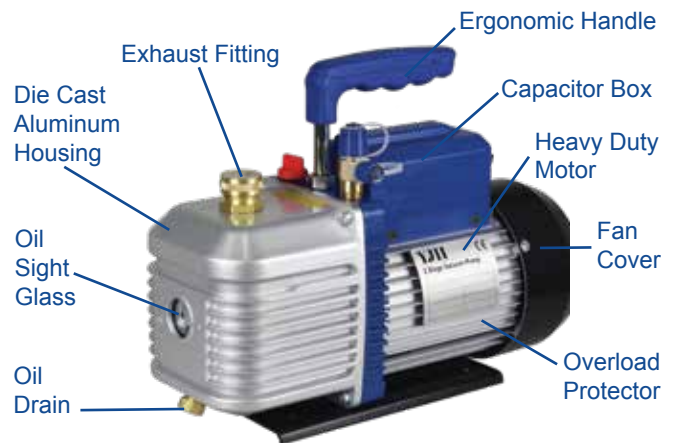

## MaxFlow™ EVACUATION KITS



- Perform A/C and refrigeration system evacuations at least 4x faster than using 1/4" hoses
- Reduce the time it takes to pull and hold vacuum leaving a tight and dry system
- 1/4" (93887) and 5/16" (93889) Core/Vacuum/Charge Tools removes cores that cause restriction
- 1/2" large diameter hose creates full, quicker flow
- Heavy duty hose won't collapse
- Vacuum rated to 20 microns
- Opens up over 90% of internal diameter of access hose
- Made in the USA

UPC#	Description
93887	MAXFLOW™ Evacuation Kit 3/8" x 1/4" 45°
93889	MAXFLOW™ Evacuation Kit 3/8" x 5/16" 45°



CHARGING SYSTEMS  
 GAUGES  
 RECOVERY MACHINES  
**VACUUM PUMP SYSTEMS**  
 VACUUM AND CHARGING HOSES  
 HOSE ADAPTERS, VALVES & PARTS  
 WIRELESS AND ELECTRONIC INSTRUMENTS  
 LEAK DETECTORS AND MONITORS  
 HEATING INSTRUMENTS  
 SYSTEM TOOLS

## SUPEREVAC™ PUMP FOR AMMONIA SYSTEMS



Designed and built to the same quality specifications as other SUPEREVAC™ pumps.

Features a pump exhaust that doubles as an oil fill port.



	Model 93530	Model 93533*
Free air displacement	8.0 cfm	190 L/M (50 Hz)
Number of stages	2-stage rotary vane	2-stage rotary vane
Field blankoff	15 microns	15 microns
Intake	1/2" Male pipe	1/2" Male pipe
Motor	1/2 hp – 1725 rpm	1/2 hp – 1425 rpm (50 Hz)
Thermal overload	Yes	Yes
Voltage	115V/60 Hz	115/230V 50 Hz*
Power cord	6' – rocker style switch	6' – rocker style switch
Oil capacity	47 oz.	47 oz.
Dimensions	17.5" L x 6.0" W x 11.5" H	18.25" L x 6.0" W x 11.5" H
Net weight	36.2 lbs. (16.4 kg)	38.8 lbs. (17.6 kg)

\* The 93533 is factory wired for 230V. It can also be configured for 115V. Remove the motor switch plate and make connections as shown on the motor label.

For replacement parts, refer to the manual (also available at [yellowjacket.com](http://yellowjacket.com))

## BELT DRIVE VACUUM PUMPS (0.88-17.7 cfm) by Hyvac Products

These two-stage pumps are lab rated at 0.1 micron and feature large oil capacity, vented exhaust, standard belt guards, motor capacitors and automatic overload protection. Optional exhaust filters available.

One year warranty.



UPC#	80200	80210	80220	80230	80240
cfm - free air (L/M)	0.88 (25)	2.79 (79)	5.6 (160)	10.6 (310)	17.7 (500)
Ultimate vacuum (lab)	0.1 micron	0.1 micron	0.1 micron	0.1 micron	0.1 micron
Stages	2	2	2	2	2
Motor hp (ODP)	1/4	1/3	1/2	1	1-1/2
Voltage (single phase)	115V/60 Hz	115V/60 Hz	115V/60 Hz	115V/60 Hz	115V/60 Hz
Pump rpm	580	525	525	525	550
Oil capacity	1 quart	1-1/2 quart	2.5 quarts	3.5 quarts	4.5 quarts
Gas ballast	Standard	Standard	Standard	Standard	Standard
Intake O.D.	9/16"	7/8"	1-1/4"	1-5/16"	1-13/16"
Dimensions (L x W x H)	15" x 10" x 11"	18" x 12" x 11"	18" x 13" x 16"	18" x 16" x 19"	21" x 20" x 20"
Shipping weight	70 lbs.	110 lbs.	135 lbs.	154 lbs.	242 lbs.

For special electrical requirements, contact factory. Some 50 Hz available for export.



## VACUUM PUMP OIL

YELLOW JACKET® vacuum pump oil is specially refined and formulated for extremely low vapor pressure and high pump efficiency at all temperature conditions to help keep your pump running for years.



SDS sheet on website

UPC#	Description
93091	Pint of vacuum oil - 24 per case
93092	Quart of vacuum oil - 12 per case
93096	Gallon of vacuum oil - 6 per case



## OIL EXHAUST FILTER

Screws onto the pump exhaust to eliminate oil mist. Use on SUPEREVAC™ and BULLET® pumps.



UPC#	Description
93386	Exhaust filter
93387	Replacement element

## SUPEREVAC™ EVACUATION MANIFOLDS



SUPEREVAC™ manifolds are engineered as system components for the SUPEREVAC pumps to help decrease vacuum time by over 50 percent and improve micron readings. Mounts with 1/2" or 3/8" Female flare quick coupler and provides easy connections for two 3/8" vacuum hoses.

- Flutterless™ gauge
- Non-restricting, full flow valves for fast vacuum
- Convenient 1/4 turn full flow
- Extra port for electronic gauge
- Now includes step-down adapter to connect to 3/8" pump intake
- Made in the USA 

### 3/8" Female flare coupler

UPC#	Description
93851	Single valve with 1/4" Schrader mount with 3/8" Female flare
93852	Single valve with lo-side gauge mount with 3/8" Female flare
93853	Two valves with lo-side gauge mount with 3/8" Female flare
19011	CH-11 gasket (10 pak)
19131	Pump step-down adapter - 1/2" Female flare to 3/8" Male flare

### 1/2" Female flare coupler

UPC#	Description
93850	Single valve with 1/4" Schrader mount with 1/2" Female flare
93855	Single valve with lo-side gauge mount with 1/2" Female flare
93860	Two valves with lo-side gauge mount with 1/2" Female flare
19015	CH-80 gasket (10-pak)
19133	Pump step-up adapter - 3/8" Female flare to 1/2" Male flare

### Additional replacement parts

UPC#	Description
19030	3/8" "O" ring (10 pak)
19096	Ball valve replacement handles (2 pak)
40272	1/4" Male flare with Schrader for 93850
41139	3/8" Male flare x 1/4" NPT Male fitting
49016	Blue compound °F gauge
77921	1/4" Flare x 1/8" NPT Male elbow
93211	3/8" Flare cap with gasket
93854	1/2" Flare connector
93847	3/8" Flare connector for 93846
93858	3/8" Flare connector for 93851-53

## SUPEREVAC™ EVACUATION SYSTEMS I, II & III



All system components are available separately, but system pricing makes I, II and III attractive buys.



All systems include a two-valve manifold and two 3/8" vacuum hoses for a fast vacuum. Vacuum valves, included with all systems, allow core removal and system isolation. This combination reduces vacuum time by over 50 percent compared to using a regular 1/4" manifold and evacuating through only one side.

System II adds 69075 electronic gauge and standard ratchet wrench to the basic System I.

System III adds a 6 or 8 cfm SUPEREVAC™ pump to System II.

UPC# for 1/2"	Description	UPC# for 3/8"
93865	System I: 2-valve manifold, 2 16248 48" vacuum hoses, 2 valves	93866
93875	System II: all of above plus 69075 electronic vacuum gauge and ratchet wrench	93876
93886 (8 cfm)	System III: all of above plus a SUPEREVAC pump	93885 (6 cfm)
	CH-11 gasket (10 pak)	19011
19015	CH-80 gasket (10 pak)	

## 1/4" AND 5/16" BALL VALVE 4-IN-1 VACUUM/CHARGE VALVE & CORE TOOL

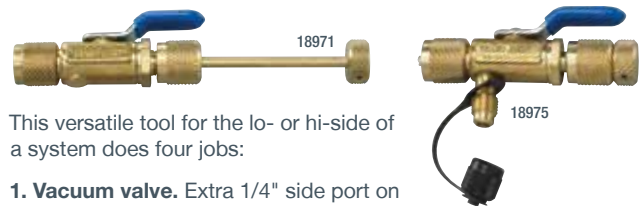

This versatile tool for the lo- or hi-side of a system does four jobs:

- Vacuum valve.** Extra 1/4" side port on 18975 to attach electronic micron vacuum gauge right at system for greater accuracy. Working pressure of 800 psi.
- Core removal access.** Lets you evacuate and charge through an unrestricted line for increased speed and higher vacuum.
- Core replacement.**
- Recovery valve.** Core removal speeds recovery process.

Made in the USA 

UPC#	Description
18971	1/4" Vacuum/charge valve without side port
18975	1/4" Vacuum/charge valve with side port
18981	5/16" Vacuum/charge valve without side port
18985	5/16" Vacuum/charge valve with side port
18986	1/4" Male x 5/16" female vacuum/charge valve

## OMNI™ DIGITAL VACUUM GAUGE



The YELLOW JACKET® OMNI™ Digital Vacuum Gauge is an easy-to-use, compact vacuum gauge that is loaded with features for the price. And it's rugged, too. Made with high impact, glass reinforced housing, it survives moisture and accidental drops or attachment to a high pressure line. The easy-to-clean vacuum sensor handles 450 psi positive pressure and reads several units of vacuum (microns, millibar, Torr and Pascal).

- Audio and visual signal when target vacuum level is reached
- Electronic paper display for clear visibility – even in direct sunlight
- Rich and intuitive user interface – turn it on and it is ready to use with default settings
- 45° degree bend for fitting (1/4" or 5/16")
- Automatic power down and time out
- Power savings - multiple time-out selections
- Low battery indicator and automatic power-down when inactive
- Adapter fittings available
- Made in the USA 

*Compact, easy-to-use, and more unique features than any other unit on the market.*

### Specifications

#### Vacuum Reading Resolution:

- 1 micron (from 1,000 to 5 microns)
- 10 microns (from 10,000 to 1,000 microns)
- 100 microns (from 25,000 to 10,000 microns)

#### Display Vacuum Measurement Accuracy:

- +/- 20% of reading (from 10,000 to 25 microns)

#### Vacuum Reading Range:

- 5 to 25,000 Microns  
(33.3 mBar, 25 Torr, 3330 Pa);
- Progress bar-graph from Atmosphere (ATM) to 25,000 Microns

#### Proof Pressure: 450 psi

#### Working Temperature: 32°F to 104°F (0°C to 40°C)

#### Storage Temperature: -4°F to 140°F (-20°C to 60°C)

#### Working Humidity: 0-95% RH (non-condensing) I

#### Class: IP-50

#### Battery Life: 100+ hours continuous

#### Battery: (2) AAA batteries (included)

#### Size: 6" long x 1.6" wide x 1.6" thick including fitting (15.3 x 4 x 4 cm)

#### Weight: 0.39 lb (175 grams)

#### Warranty: One year

UPC#	Description
69020	OMNI™ Digital Vacuum Gauge with 1/4" Coupler
69021	OMNI™ Digital Vacuum Gauge with 5/16" Coupler



## VACUUM SENSOR CLEANING KIT

Follow cleaning procedure for these YELLOW JACKET® vacuum gauges: 69020 series OMNI™, 67030 series used with P51 digital manifold and Mantooth gauges or 69086 digital vacuum gauge.

Made in the USA 

UPC#	Description
69030	Vacuum Sensor Cleaning Kit



## SUPEREVAC™ LCD VACUUM GAUGE

### Full range from atmosphere to 1 micron

The SUPEREVAC™ LCD vacuum gauge combines thermocouple sensor technology with advanced electronics for precise readings and repeatability not found with thermistor sensors or analog meters.

Thermocouple technology has long been proven in laboratory and precision industrial instrumentation for sensing the deep vacuum range. Thermocouple sensors are factory calibrated and exhibit few of the electronic variances of thermistor sensors found in many other electronic gauges. Durable molded case with storage for sensor, cable and brass connector.

#### Specifications

Response time: 3 seconds  
 Calibration: Automatic  
 Warm up: 3 seconds  
 Sensor cable: 5.5' (167 cm) coiled  
 Sensor connection: 1/4" Male flare  
 Maximum pressure: To avoid sensor damage, do not exceed 5 psig  
 Operating temperature range: 32° to 120°F (0° to 49°C)  
 Display: 0.5" LCD with battery check  
 Automatic shut-off: Yes  
 Power: D cell battery, 70 hours continuous battery life  
 Dimensions: 9" x 12.25" x 2.37" (230 mm x 310 mm x 60 mm)  
 Accuracy: ± 20% of reading

UPC#	Description
69075	SUPEREVAC™ LCD vacuum gauge full range complete in case
69067	Optional ball valve to add to sensor 1/8" NPT Female x 1/4" Female flare
69071	Brass connector 1/4" Female flare x 1/4" Female flare
69073	Replacement sensor for 69070, 69075
19110	Optional coupler to add to sensor 1/8" NPT Female x 1/4" Female flare
69058	Replacement cord



69058 cord

69073 sensor

69071 connector

#### Thermocouple sensor features:

- No adjustments or warm-up. Stays calibrated after on/off switching and long evacuations
- Automatic battery compensation
- Automatic ambient temperature compensation
- Replacement sensor requires no calibration

#### LCD gauge features:

- Automatic off 20 minutes after power up and no change
- Normal handling and jarring will not affect the LCD reading
- Case protects electronic circuitry and sensor
- Calibration standards traceable to NIST
- Precision circuitry controls sensor and translates sensor input into micron readings
- Made in the USA 

## DIGITAL LCD ECONOMY VACUUM GAUGE



This product is protected by one or more of U.S. Patent Number: 6,779,350; 6,832,491; 7,073,346; 7,310,965; and 7,428,822.

The digital LCD economy vacuum gauge indicates air and moisture have been removed from the system. Track down the 14 level bargraph from atmosphere to 25 microns to know that the system is clean and the vacuum pump is performing properly. Packaged complete with 9V alkaline battery and hanging hook.

- Unique thermal conductivity sensor automatically compensates for temperature with no calibration
- Simple On/Off controls
- Easy-to-clean sensor handles 450 psi positive pressure
- Rugged contractor-grade construction with tough ABS housing and solid state circuitry for accuracy
- Automatic battery saver shuts gauge off after 20 minutes with no reading changes
- Low battery indicator
- Calibration standards traceable to NIST
- Patented technology
- Made in the USA 

To keep the 69080 vacuum gauge accurate, it is best to avoid oil contamination. Keep the sensor vertical whenever possible and connect the gauge directly to the system, away from the pump.

UPC#	Description
69080	Digital LCD vacuum gauge with battery, hook and pouch
69081	Replacement soft-sided protective case
69079	Replacement battery door and screw
69095	Tee fitting

CHARGING SYSTEMS  
 GAUGES  
 RECOVERY MACHINES  
**VACUUM PUMP SYSTEMS**  
 VACUUM AND CHARGING HOSES  
 HOSE ADAPTERS, VALVES & PARTS  
 WIRELESS AND ELECTRONIC INSTRUMENTS  
 LEAK DETECTORS AND MONITORS  
 HEATING INSTRUMENTS  
 SYSTEM TOOLS

## DIGITAL VACUUM GAUGE

### Seven units of vacuum for confidence

This easy-to-use gauge shows that air and moisture have been removed from the system. Simple push of a button changes the display readout between 7 units of measurement. **Each displays from atmosphere to 10 microns (bargraph indication above 25000 microns) of vacuum to let you know that your vacuum pump is clean and performing properly.** If the sensor gets dirty, simply plug a new sensor into the gauge, run through a quick calibration process and be back on the job within minutes.



This product is protected by one or more of U.S. Patent Number: 6,779,350; 6,832,491; 7,073,346; 7,310,965; and 7,428,822.

- Unique patented thermal conductivity sensor automatically compensates for temperature
- Replaceable, cleanable, plug-in sensor (Part #69087) handles 450 psi positive pressure
- Displays seven different units of vacuum (microns, milli Torr, Torr, millimeters of mercury, millibar, kiloPascal and Pascal)
- 12" coiled sensor cord stretches to 24" for easy reach, connectivity and readability of display
- Low battery indicator
- Automatic shut-off after 20 minutes
- Calibration standards traceable to NIST
- 32° to 122°F (0° to 50°C) operating temperature range
- 14 oz. (392 g) with battery
- Approximately 25 hours continuous battery life
- Accuracy ±20% of reading
- Made in the USA 

UPC#	Description
69086	Hand-held vacuum gauge with fabric carry pouch
69087	Replacement sensor for older models without detachable cords
69088	Replacement cable for original version - not detachable
40819	Replacement cable for new version - detachable
69101	Replacement sensor and cord assembly
69091	Replacement fabric pouch
69030	Vacuum Sensor Cleaning Kit

## VACUUM PUMP ADAPTER

Convert a 3/8" or 1/2" vacuum pump intake into flare and Acme compatible fittings.



UPC#	Description
36018	1/2" Pump adapter with 1/4" flare and 1/2" Acme Male fittings
19015	1/2" Replacement gaskets for 36018 (10 pak)
36019	3/8" Pump adapter with 1/4" flare and 1/2" Acme Male fittings
19011	3/8" Replacement gaskets for 36019 (10 pak)

## VACUUM PUMP INTAKE REDUCER ADAPTER



UPC#	Description
19030	Rubber gasket "O" ring (10 pak) for 19130 and 19133
19130	3/8" Female fl. x 1/4" Male fl. adapter
19131	1/2" Female fl. x 3/8" Male fl. adapter
19132	1/2" Female fl. x 1/4" Male fl. adapter
19133	3/8" Female fl. x 1/2" Male fl. adapter
19160	1/2" Female fl. x 1/2" Male Acme adapter
93058	Rubber gasket "O" ring for 19131, 19132 and 19160

## HEAT GUN

600° and 1000°F settings. Shockproof and tough housing is durable and lightweight. Use for:

- Coil defrosting
- Faster vacuums
- Drying out condensation in motors, clutches, etc.



Kits include gun, adapters and case.

UPC#	Description
69092	Heat gun kit 115V - UL, CSA

## MECHANICAL VACUUM GAUGES



Mechanical vacuum gauges for system installation. Bourdon tube type gauge. 1/8" NPT Male bottom fitting. CAUTION: Handle gauges carefully to assure full service life. See page 53 for further details.

UPC#	Description
69044	3 1/8" Vacuum gauge 0-30 inHg/760-0 Torr (mm)
69045	3 1/8" Vacuum gauge European version (1000-0 millibar/30-0 inch)

# VACUUM AND CHARGING HOSES



CHARGING SYSTEMS

GAUGES

RECOVERY MACHINES

VACUUM PUMP SYSTEMS

**VACUUM AND CHARGING HOSES**

HOSE ADAPTERS, VALVES & PARTS

WIRELESS AND ELECTRONIC INSTRUMENTS

LEAK DETECTORS AND MONITORS

HEATING INSTRUMENTS

SYSTEM TOOLS



CHARGING  
SYSTEMS

GAUGES

RECOVERY  
MACHINES

VACUUM PUMP  
SYSTEMS

VACUUM AND  
CHARGING HOSES

HOSE ADAPTERS,  
VALVES & PARTS

WIRELESS AND  
ELECTRONIC  
INSTRUMENTS

LEAK DETECTORS  
AND MONITORS

HEATING  
INSTRUMENTS

SYSTEM TOOLS



**YELLOW  
JACKET®**

## THE ANATOMY OF A HOSE

- 1/4" **PLUS II™** hoses are UL recognized assemblies (File SA9737)
- The nylon permeation barrier meets SAE requirements J2196 for CFC, HCFC and HFC refrigerants
- The moisture barrier provides improved resistance to moisture migration which contaminates expensive refrigerant
- 1/4" RYB **PLUS II™** hoses are rated for 4000 psi (276 bar) minimum burst and 800 psi (55 bar) maximum working pressure and an operating temperature of -20° to 180°F (-28.8° to 82.2°C)
- Minimum bend radius: 6" (152 mm)
- Made in the USA 

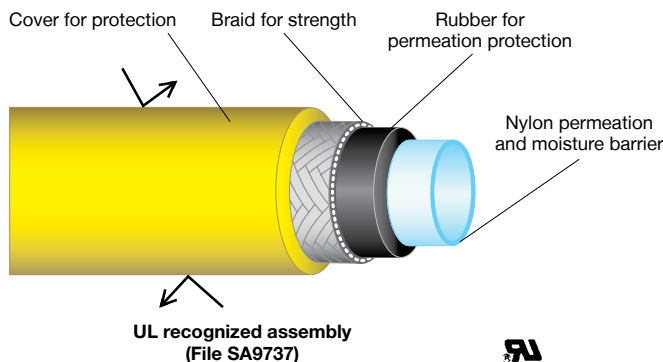

### **PLUS II™ hoses with UL assemblies are available in the following configurations:**

- 1/4" with 1/4" flare fittings
- 1/4" with compact ball valve end
- 1/4" with SealRight™ low loss anti-blow back fitting
- 1/4" for 5/16" flare (1/2 – 20 thread) service ports for R-410A
- 1/4" with FlexFlow™ valve

<b>PLUS II™ hose - standard 1/4" flare fittings</b>				
Length	Yellow	Blue	Red	3 pak*
12"	21012	21212	21612	-
24"	21024	21224	21624	-
36"	21036	21236	21636	21983
48'	21048	21248	21648	21984
60"	21060	21260	21660	21985
72"	21072	21272	21672	21986
96"	21096	21296	21696	21988
10'	21110	21310	21710	-
12'	21112	21312	21712	-
25'	21125	21325	21725	-
50'	21150	21350	21750	-
75'	21175	21375	21775	-
100'	21200	21399	21799	-
Multi-length				21982 two 36", one 60" 21981 two 36", one 72"

\* 3 pak includes a red, yellow and blue hose.

<b>Replacement parts</b>	
UPC#	Description
19020	Replacement gasket (10 pak)
19302	"Adjust-a-Valve" opener (10 pak)

CHARGING SYSTEMS  
GAUGES  
RECOVERY MACHINES  
VACUUM PUMP SYSTEMS  
VACUUM AND CHARGING HOSES  
HOSE ADAPTERS, VALVES & PARTS  
WIRELESS AND ELECTRONIC INSTRUMENTS  
LEAK DETECTORS AND MONITORS  
HEATING INSTRUMENTS  
SYSTEM TOOLS

CHARGING SYSTEMS  
GAUGES  
RECOVERY MACHINES  
VACUUM PUMP SYSTEMS  
VACUUM AND CHARGING HOSES  
HOSE ADAPTERS, VALVES & PARTS  
WIRELESS AND ELECTRONIC INSTRUMENTS  
LEAK DETECTORS AND MONITORS  
HEATING INSTRUMENTS  
SYSTEM TOOLS

## PLUS II™ 1/4" HOSE With compact ball valve end

Designed for R-410A



- Metal handle at end of hose fits tight areas and traps all the gas
- Full flow valve
- Uses standard gasket and valve opener
- Made in the USA 

UL recognized assemblies (File SA9737)

Compact ball valve end					
Length	Yellow	Blue	Red	3 pak	Black
36"	29036	29236	29636	29983	–
48"	29048	29248	29648	29984	–
60"	29060	29260	29660	29985	29595
72"	29072	29272	29672	29986	–
96"	29096	29296	29696	29988	–
10'	29110	29310	29710	–	–
12'	29112	29312	29712	–	–
25'	29125	29325	29725	–	–
50'	29150	29350	29750	–	–
75'	29175	29375	29775	–	–
100'	29199	29399	29799	–	–

Replacement parts	
UPC#	Description
19020	Replacement gasket (10 pak)
19302	"Adjust-a-Valve" opener (10 pak)

## PLUS II™ 1/4" HOSE With FlexFlow™ valve

Designed for R-410A



- Valve handle position shows when valve is opened or closed
- Metal handle and smaller ergonomic valve with zero restriction for maximum flow
- Flexible length of hose between valve and fitting makes access to tight areas easier
- Made in the USA 

UL recognized assemblies (File SA9737)

FlexFlow™ valve 8" from angle end				
Length	Yellow	Blue	Red	3 pak
36"	25036	25236	25636	25983
48"	25048	25248	25648	25984
60"	25060	25260	25660	25985
72"	25072	25272	25672	25986
96"	25096	25296	25696	25988
10'	25110	25310	25710	–
12'	25112	25312	25712	–
25'	25125	25325	25725	–
50'	25150	25350	25750	–
75'	25175	25375	25775	–
100'	25199	25399	25799	–

Replacement parts	
UPC#	Description
19020	Replacement gasket (10 pak)
19302	"Adjust-a-Valve" opener (10 pak)

## PLUS II™ 1/4" HOSE With SealRight™ low loss anti-blow back fitting



Designed for R-410A

UL recognized assemblies (File SA9737)

- Low loss anti-blow back SealRight fitting immediately traps refrigerant in the hose when disconnected, helping meet non-venting regulations and prevent finger burns
- 45° end for easy installation in tight areas
- Gaskets resist deterioration from existing CFC, HCFC and HFC refrigerants and oils
- Available with SealRight fittings on both ends
- Made in the USA 

45° SealRight fitting at one end				
Length	Yellow	Blue	Red	3 pak
12"	22012	22212	22612	–
24"	22024	22224	22624	–
36"	22036	22236	22636	22983
48"	22048	22248	22648	22984
60"	22060	22260	22660	22985
72"	22072	22272	22672	22986
96"	22096	22296	22696	22988
10'	22110	22310	22710	–
12'	22112	22312	22712	–
25'	22125	22325	22725	–
50'	22150	22350	22750	–
75'	22175	22375	22775	–
100'	22200	22399	22799	–

UPC#	Multi-length 3 pak
22981	Two 36" RB, one 72" Y
22982	Two 36" RB, one 60" Y

Replacement parts	
UPC#	Description
19020	1/4" and 5/16" Replacement gasket (10 pak)
19037	SealRight "O" ring (10 pak)
19038	Plug and gasket
19039	Nut and clip
19040	SealRight repair kit with valve, gasket, plug, spring and two "O" rings
19041	Complete kit includes 19038, 19039 and 19040



## PLUS II™ 1/4" HOSE For 5/16" flare (1/2 – 20 thread) service ports for R-410A



UL recognized assemblies (File SA9737)

- Available with standard fittings or compact ball valve
- Compatible with both POE and PVE oils
- Made in the USA

**PLUS II™** hose with 1/4" (7/16 – 20) Female flare on manifold connection and 5/16" (1/2 – 20) Female flare angled on service end

Standard fitting			
Length	Yellow	Blue	Red
36"	21403	21423	21463
60"	21405	21425	21465
72"	21406	21426	21466

For use with R-410A tanks with 1/4" fittings  
\*Yellow PLUS II™ hose with standard 1/4" (7/16 – 20) flare fittings

Length	3 pak
36"	21483 (21036*, 21423, 21463)
60"	21485 (21060*, 21425, 21465)
72"	21486 (21072*, 21426, 21466)

**PLUS II™** hose with 5/16" (1/2 – 20) Female flare on manifold connection and 5/16" (1/2 – 20) Female flare angled on service end

Standard fitting				
Length	Yellow	Blue	Red	3 pak
36"	21503	21523	21563	21583
60"	21505	21525	21565	21585
72"	21506	21526	21566	21586

**PLUS II™** hose with compact ball valve (1/4" x 5/16")

Length	Yellow	Blue	Red
36"	29403	29423	29463
60"	29405	29425	29465
72"	29406	29426	29466

For use with R-410A tanks with 1/4" fittings  
\*Yellow PLUS II™ hose with 1/4" (7/16 – 20) compact ball valve fittings

Length	3 pak
36"	29483 (29036*, 29423, 29463)
60"	29485 (29060*, 29425, 29465)
72"	29486 (29072*, 29426, 29466)

**Compact ball valve (RYB 5/16" x 5/16")**

Length	Yellow	Blue	Red	3 pak
36"	29003	29203	29603	29993
60"	29005	29205	29605	29995
72"	29006	29206	29606	29996

**Replacement parts**

UPC#	Description
19020	1/4" and 5/16" Replacement gasket (10 pak)
19302	"Adjust-a-Valve" opener (10 pak)

## 9" FlexFlow™ AND LOW LOSS ADAPTER HOSES



UL recognized assemblies (File SA9737)  
(Valves SA10088) (except 25802 and 26002)

Designed for R-410A

- Easy retrofit of existing PLUS II™ hoses with ball valve capabilities
- Flexible hose between valve and fitting for handling in tight areas
- Operating temperature -20° to 180°F (-28.8° to 82.2°C)\*\*
- 800 psi working pressure\*\*\*
- Minimum bend radius: 8" (203 mm)
- Made in the USA

**Compact ball valve assemblies**

UPC#	Description
29001	1/4" Yellow ball valve adapter
29201	1/4" Blue ball valve adapter
29601	1/4" Red ball valve adapter
29980	29001, 29201, 29601 (3 pak)
93843	1/4" Compact ball valve – 45°
93842	1/4" Compact ball valve – 45° (3 pak)

**FlexFlow™ assemblies**

UPC#	Description
29011	1/4" to 5/16" Yellow FlexFlow adapter <b>NEW!</b>
29211	1/4" to 5/16" Blue FlexFlow adapter <b>NEW!</b>
29611	1/4" to 5/16" Red FlexFlow adapter <b>NEW!</b>
25002	1/4" Yellow FlexFlow adapter
25202	1/4" Blue FlexFlow adapter
25602	1/4" Red FlexFlow adapter
25980	25002, 25202, 25602 (3 pak)
25802	1/4" Heavy duty FlexFlow adapter*
26002	3/8" Heavy duty FlexFlow adapter****
26202	Yellow standard "B" FlexFlow adapter**/***
27002	Acme 1/2" Yellow FlexFlow adapter
19095	Set of 2 handles and screws

\*25802 and 26002: Operating temperature -22° to 176°F (-30° to 80°C)

\*\*26202: Operating temperature -20° to 200°F (-28.8° to 93.3°C)

\*\*\*26002 and 26202: 3000 psi (207 bar) burst and 600 psi (41 bar) working pressures

**Replacement parts**

UPC#	Description
19011	3/8" Replacement gasket (10 pak)
19020	1/4" Replacement gasket (10 pak)
19302	"Adjust-a-Valve" opener (10 pak)

Underwriters Laboratories Inc. Registered Component Mark – applies to all standard 1/4" PLUS II™ and 1/4" RYB FlexFlow™ hoses

CHARGING SYSTEMS  
GAUGES  
RECOVERY MACHINES  
VACUUM PUMP SYSTEMS  
VACUUM AND CHARGING HOSES  
HOSE ADAPTERS, VALVES & PARTS  
WIRELESS AND ELECTRONIC INSTRUMENTS  
LEAK DETECTORS AND MONITORS  
HEATING INSTRUMENTS  
SYSTEM TOOLS



## PLUS II™ 3/8" "B" CHARGING HOSE

Designed for R-410A

PLUS II™ features in a larger volume hose for fast, high vacuum or charging.

- 3000 psi (207 bar) minimum burst, 600 psi (41 bar) maximum working pressure
- Operating temperature -20° to 180°F (-28.8° to 82.2°C)
- Minimum bend radius: 6" (152 mm)
- Large selection of fittings available
- Made in the USA

Replacement parts	
UPC#	Description
19011	3/8" Replacement gasket (10 pak)

Length	Common selections					Other selections				
	3/8" Str. fl. x 3/8" Str. fl.			3/8" fl. x FlexFlow	3/8" Str. fl. x 3/8" 45°			3/8" Str. fl. x 3/8" 90°	1/4" Str. fl. x 1/4" 45°	
	Yellow	Blue	Red		Yellow	Blue	Red			
36"	14536	B36	27836	28036	26236	18136	28236	28436	20036	20436
48"	14548	B48	27848	28048	26248	18148	28248	28448	20048	20448
60"	14560	B60	27860	28060	26260	18160	28260	28460	20060	20460
72"	14572	B72	27872	28072	26272	18172	28272	28472	20072	20472
96"	14596	B96	27896	28096	26296	18196	28296	28496	20096	20496
10'	14610	B120	27910	28110	26310	18210	28310	28510	20110	20510
12'	14612	B144	27912	28112	26312	18212	28312	28512	20112	20512
25'	14625	B300	27925	28125	26325	18225	28325	28525	20125	20525
50'	14650	B600	27950	28150	26350	18250	28350	28550	20150	20550
75'	14675	B900	27975	28175	26375	18275	28375	28575	20175	20575
100'	14699	B1200	27999	28199	26399	18299	28399	28599	20199	20599



## PLUS II™ 1/4" HEAVY DUTY CHARGING HOSE

Designed for R-410A

Heavy duty construction for substantially increased service life.

- Flexibility for all-weather easy handling
- Pulls 75 micron vacuum or better on 36" hose
- 4000 psi (276 bar) minimum burst, 800 psi (55 bar) maximum working pressure
- Operating temperature -22° to 176°F (-30° to 80°C)
- Minimum bend radius: 6" (152 mm)
- Made in the USA

Replacement parts	
UPC#	Description
19020	Replacement gasket (10 pak)
19302	"Adjust-a-Valve" opener (10 pak)

Length	Common selections			Other selections				
	HCA hose Str. x angle		Hose with FlexFlow™	Hose with ball valve	HCL hose Str. x 90°		HCS hose Str. x Str.	
12"	15012	HCA-12"	-	-	15212	HCL-12"	15412	HCS-12"
24"	15024	HCA-24"	-	-	15224	HCL-24"	15424	HCS-24"
36"	15036	HCA-36"	25836	29836	15236	HCL-36"	15436	HCS-36"
48"	15048	HCA-48"	25848	29848	15248	HCL-48"	15448	HCS-48"
60"	15060	HCA-60"	25860	29860	15260	HCL-60"	15460	HCS-60"
72"	15072	HCA-72"	25872	29872	15272	HCL-72"	15472	HCS-72"
96"	15096	HCA-96"	25896	29896	15296	HCL-96"	15496	HCS-96"
10'	15110	HCA-120"	25910	29910	Black only. Longer lengths available. Please specify.			
12'	15112	HCA-144"	25912	29912				
25'	15125	HCA-300"	25925	29925				
50'	15150	HCA-600"	25950	29950				
75'	15175	HCA-900"	25975	29975				
100'	15199	HCA-1200"	25999	29999				

## PLUS II™ 3/8" HEAVY DUTY COMBINATION CHARGING/VACUUM HOSE

Pulls a vacuum much faster than the 1/4" hose.

- Operating temperature -22° to 176°F (-30° to 80°C)
- 3000 psi (207 bar) minimum burst, 600 psi (41 bar) maximum working pressure
- Minimum bend radius: 8" (203 mm)
- **Vacuum rated to 20 microns**
- Made in the USA 



Replacement parts	
UPC#	Description
19020	1/4" Replacement gasket (10 pak)
19011	3/8" Replacement gasket (10 pak)
19302	"Adjust-a-Valve" opener (10 pak)

Common selections				Other selections				
Length	3/8" Str. fl. x 3/8" Str. fl.	3/8" Str. fl. x FlexFlow™		3/8" fl. x 3/8" 45°	3/8" fl. x 3/8" 90°	3/8" fl. x 1/4" 45°	1/4" fl. x 1/4" 45°	
36"	15636 BC-36"	26036		19636	19836	16236 BCA-36"	20236	
48"	15648 BC-48"	26048		19648	19848	16248 BCA-48"	20248	
60"	15660 BC-60"	26060		19660	19860	16260 BCA-60"	20260	
72"	15672 BC-72"	26072		19672	19872	16272 BCA-72"	20272	
96"	15696 BC-96"	26096		19696	19896	16296 BCA-96"	20296	
10'	15710 BC-120"	26110		19710	19910		20310	
12'	15712 BC-144"	26112		19712	19912	Longer lengths available. Please specify. Longer than 8' not recommended for evacuation.	20312	
25'	15725 BC-300"	26125		19725	19925		20325	
50'	15750 BC-600"	26150		19750	19950		20350	
75'	15775 BC-900"	26175		19775	19975		20375	
100'	15799 BC-1200"	26199		19799	19999		20399	

## PLUS II™ 1/2" AND 5/8" HEAVY DUTY COMBINATION CHARGING/VACUUM HOSE

Heavy duty construction with PLUS II™ barrier technology reduces permeation and vacuum loss. Large I.D. reduces vacuum time substantially over 1/4" or 3/8" hose.

- Pull a more complete vacuum
- Faster refrigerant transfer
- Faster charging on large systems
- 3000 psi (207 bar) minimum burst, 600 psi (41 bar) maximum working pressure
- Operating temperature -22° to 176°F (-30° to 80°C)
- Other fittings available on request
- Minimum bend radius: 10" (254 mm)
- **Vacuum rated to 20 microns**
- Made in the USA 



Replacement parts	
UPC#	Description
19015	1/2" and 5/8" Replacement gaskets
19020	1/4" Replacement gasket (10 pak)
19011	3/8" Replacement gasket (10 pak)
19302	"Adjust-a-Valve" opener (10 pak)

Common selections				Other selections			
Length	"C" 1/2" fl. x 1/2" fl.	"D" 5/8" fl. x 5/8" fl.		"CA" 1/4" angle end x 1/2" fl.	"DA" 1/4" angle end x 5/8" fl.	1/2" fl. x 3/8" fl.	3/8" fl. x 3/8" fl.
36"	15836 C-36"	16036 D-36"		16436 CA-36	16636 DA-36	19236	20636
48"	15848 C-48"	16048 D-48"		16448 CA-48	16648 DA-48	19248	20648
60"	15860 C-60"	16060 D-60"		16460 CA-60	16660 DA-60	19260	20660
72"	15872 C-72"	16072 D-72"		16472 CA-72	16672 DA-72	19272	20672
96"	15896 C-96"	16096 D-96"		16496 CA-96	16696 DA-96	19296	20696
10'	15910 C-120"	16110 D-120"				19310	20710
12'	15912 C-144"	16112 D-144"				19312	20712
25'	15925 C-300"	16125 D-300"		36" hose will pull to 20 microns and lower. Hoses longer than 8' not recommended for evacuation.		19325	20725
50'	15950 C-600"	16150 D-600"				19350	20750

Black only. Longer lengths available. Specify type, length and fitting combination.



## PLUS II™ 3/4" HEAVY DUTY CHARGING HOSE



Large 3/4" I.D. designed to save time in charging or evacuation of centrifugals and other large systems.

- Constructed for heavy duty use with most refrigerants
- 3000 psi (206 bar) minimum burst, 600 psi (41 bar) maximum working pressure
- Available with steel 3/4" Female, 3/4" Male flares, 3/4" Male pipe or hex fittings
- Operating temperature -20° to 200°F (-28.8° to 93.3°C)
- Minimum bend radius: 12" (305 mm)
- Not for use with NH<sub>3</sub>



Length	3/4" fl. x 3/4" fl. – "O" ring seal	3/4" hex x 3/4" hex copper gasket seal
12"	18412 E-12"	20812
24"	18424 E-24"	20824
36"	18436 E-36"	20836
48"	18448 E-48"	20848
60"	18460 E-60"	20860
72"	18472 E-72"	20872
96"	18496 E-96"	20896
10'	18510 E-120"	20910
12'	18512 E-144"	20912
25'	18525 E-300"	20925
50'	18550 E-600"	20950

### Replacement parts

UPC#	Description
19012	3/4" "O" ring
59655	3/4" Copper gasket

## AUTOMOTIVE MANIFOLD HOSES FOR R-134A SYSTEMS

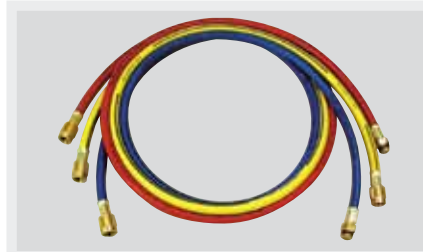

These 1/4" hoses combine PLUS II™ hose with 1/2" Acme fittings to meet SAE requirements. You get PLUS II™ double barrier protection in a hose manufactured specifically for automotive applications. Fitting threads are 1/2" Acme Female and 14 mm Male fittings.



Color	Yellow	Red	Blue	3 pak
Length	SealRight Straight x 45° Acme	1/2" fe. Acme x 14 mm Male	1/2" fe. Acme x 14 mm Male	
60"	27460	27260	27660	27102
72"	27472	27272	27672	27101
96"	27496	27296	27696	27104
10'	27510	27310	27710	27103

## AUTOMOTIVE CHARGING MANIFOLD AND HOSES FOR 1234YF SYSTEMS



Charging manifold and hoses designed specifically for 1234yf. Manifold body made of lightweight forged aluminum alloy for handling ease and the durability and reliability required for repeated use.



Color	Yellow	Blue	Red
Length	3/16" hose (12 mm barb x 45° QC)	3/16" hose (12 mm x 12 mm barb)	
36"	17803	17823	17863
48"	17804	17824	17864
60"	17805	17825	17865
72"	17806	17826	17866
96"	17808	17828	17868
120"	17810	17830	17870
144"	17812	17832	17872
180"	17815	17835	17875

### 1234yf Test & Charging Manifold

49849 TITAN 2-Valve Manifold with 72 PLUS II™ SAE RYB hoses with couplers, R/B gauges, bar/psi/kPa, R1234yf, °F

## SPECIAL 1/4" PLUS II™ CHARGING HOSES

YELLOW JACKET 1/4" yellow charging hoses with special fittings include straight, 3/8" and 90° fittings. Red and blue hoses also available.



Length	1/4" fl. x 1/4" 90° fl.	1/4" fl. x 1/4" fl.	1/4" fl. x 3/8" fl.
36"	12036 HL36	13036 HS36	14036 HB36
48"	12048 HL48	13048 HS48	14048 HB48
60"	12060 HL60	13060 HS60	14060 HB60
72"	12072 HL72	13072 HS72	14072 HB72

Longer lengths available. Please specify.

### Replacement parts

UPC#	Description/Quantity
19010	1/4" Gasket (6 pak) and valve depressor (3 pak)
19020	Replacement gasket (10 pak)
19302	"Adjust-a-Valve" opener (10 pak)

90° for tight areas

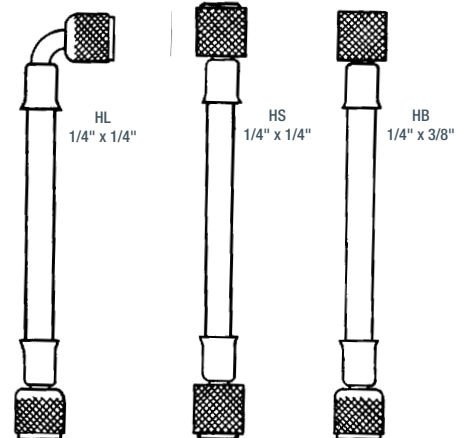

CHARGING SYSTEMS  
GAUGES  
RECOVERY MACHINES  
VACUUM PUMP SYSTEMS  
VACUUM AND CHARGING HOSES  
HOSE ADAPTERS, VALVES & PARTS  
WIRELESS AND ELECTRONIC INSTRUMENTS  
LEAK DETECTORS AND MONITORS  
HEATING INSTRUMENTS  
SYSTEM TOOLS

# HOSE COMPARISON CHART

1/4" Flexible hoses	3/8" Flexible hoses	1/2" and 5/8" Flexible hoses
Easily connects to 1/4" Male flare access fitting on system	Evacuates and charges faster than 1/4" hose	Evacuates and charges faster than 1/4" hose Allows you to pull a deeper vacuum More efficient job of removing moisture and contaminants from the system
<b>PLUS II™ 1/4" Charging hose</b> (SealRight™, FlexFlow and ball valve ends)	<b>PLUS II™ 3/8" Charging hose</b>	<b>PLUS II™ 1/2" and 5/8" Charging hose</b>
Adjust-a-Valve™ valve core depressor easily opens all out-of-tolerance Schrader valves (SealRight hoses offer different technology)  PLUS II™ hoses offer double barrier protection  Nylon layer for permeation, braid for strength, and outer cover for protection  Fully UL recognized assemblies (File SA9737)	PLUS II™ hoses with double barrier protection	PLUS II™ hoses with double barrier protection  Large I.D. reduces vacuum time substantially over 1/4" or 3/8" hose  Faster refrigerant transfer and faster charging on large systems  Wide selection of fittings are available
<b>Temp:</b> -20° to 180°F (-28.8° to 82.2°C)	<b>Temp:</b> -20° to 180°F (-28.8° to 82.2°C)	<b>Temp:</b> -22° to 176°F (-30° to 80°C)
<b>Burst:</b> 4000 psi (276 bar) minimum	<b>Burst:</b> 3000 psi (207 bar) minimum	<b>Burst:</b> 3000 psi (207 bar) minimum
<b>Working:</b> 800 psi (55 bar) maximum	<b>Working:</b> 600 psi (41 bar) maximum	<b>Working:</b> 600 psi (41 bar) maximum
<b>Safety factor:</b> 5 to 1	<b>Safety factor:</b> 5 to 1	<b>Safety factor:</b> 5 to 1
<b>Available lengths:</b> 12 inches to 100 feet	<b>Available lengths:</b> 12 inches to 100 feet	<b>Available lengths:</b> 12 inches to 100 feet



The "Adjust-a-Valve" valve core depressor easily opens out-of-tolerance Schrader valves. Simply adjust height with needle nose pliers. Designed for repeat usage; replacement is convenient.

## Inspect your hoses on a regular basis.

Since 1964, YELLOW JACKET 1/4" charging hoses have "year of manufacture" coded or listed on the rim of the nut. Prior to 2006, a series of I's, X's, O's, A's, B's or C's indicated the year. Since mid-2006, the actual year of manufacture has been used. **If your hoses are more than five years old, we recommend that you replace them.**

Fittings available PLUS II™ hoses			
Type	Str.	45°	90°
1/8" Female flare			
3/16" Female flare			
1/4" Female flare			
1/4" Female SealRight™			
3/8" Female flare			
5/16" Female flare			
1/4" Male flare			
1/8" NPT Male			
1/4" NPT Male			
1/2" Female Acme			
14 mm Male			

Not all hose and fitting combinations are listed in this catalog. Ask for specifics.

6	1964	4 BBBB	1997
1	1970	3 BBB	1998
6 IIIIII	1971	2 BB	1999
1 I	1976	1 B	2000
6 XXXXXX	1977	6 CCCCCC	2001
1 X	1982	5 CCCCC	2002
6 OOOOOO	1983	4 CCCC	2003
1 O	1988	3 CCC	2004
6 AAAAAA	1989	2 CC	2005
1 A	1994	1 C or 2006	2006
6 BBBBBB	1995	2007	2007
5 BBBB	1996		

All after 2007 are stamped with year of mfg.

Ounces of liquid held per foot of hose at 80° F					
Hose type	R-22	R-134a	R-404A	R-407C	R-410A
1/4" PLUS II™	0.33	0.33	0.29	0.31	0.29
1/4" Heavy duty	0.31	0.32	0.27	0.30	0.28
3/8" PLUS II™	0.77	0.78	0.67	0.73	0.68
3/8" Heavy duty	0.77	0.78	0.67	0.73	0.68
1/2" Heavy duty	1.68	1.70	1.47	1.60	1.49
3/4" Heavy duty	3.53	3.58	3.09	3.37	3.13

CHARGING SYSTEMS  
GAUGES  
RECOVERY MACHINES  
VACUUM PUMP SYSTEMS  
VACUUM AND CHARGING HOSES  
HOSE ADAPTERS, VALVES & PARTS  
WIRELESS AND ELECTRONIC INSTRUMENTS  
LEAK DETECTORS AND MONITORS  
HEATING INSTRUMENTS  
SYSTEM TOOLS

CHARGING SYSTEMS  
GAUGES  
RECOVERY MACHINES  
VACUUM PUMP SYSTEMS  
VACUUM AND CHARGING HOSES  
HOSE ADAPTERS, VALVES & PARTS  
WIRELESS AND ELECTRONIC INSTRUMENTS  
LEAK DETECTORS AND MONITORS  
HEATING INSTRUMENTS  
SYSTEM TOOLS

## AMMONIA CHARGING HOSE



Designed with steel quick couplers at both ends. Features include:

- Regular CH20 gaskets for 1/4" hoses (19010, 19020). CH11 gaskets for 3/8" hoses (19011)
- 1/4" and 3/8" – 2500 psi (172 bar) minimum burst, 500 psi (34 bar) maximum working pressure
- 1/4" operating temperature -20° to 176°F (-28.8° to 80°C) and minimum bend radius: 6" (152 mm)
- 3/8" operating temperature -22° to 176°F (-30° to 80°C) and minimum bend radius: 8" (203 mm)
- Made in the USA

1/4" Str. fl. x 1/4" 45°			3/8" Str. fl. both ends	
UPC#	Part#	Length	UPC#	Part#
16848	NHA-48"	48"	19448	NBC-48"
16872	NHA-72"	72"	19472	NBC-72"
16896	NHA-96"	96"	19496	NBC-96"
16910	NHA-120"	10'	19510	NBC-120"
16912	NHA-144"	12'	19512	NBC-144"

Steel half union ammonia fittings	
UPC#	Description
16801	1/4" Male fl. x 1/4" NPT Male Str.
16802	1/4" Male fl. x 1/4" NPT Male 90°
16803	3/8" Male fl. x 1/4" NPT Male

NH<sub>3</sub> manifold on page 23.

## CYLINDER VALVE HOSES

### With finger tight drum fitting

Designed for finger tight operation on 125 lb. and 145 lb. refrigerant cylinders. Gaskets seal without wrenches.



UPC#	L.	Part#	Type	Fittings	Burst pressure	Working pressure	Operating temp.	Min. bend radius
18612	12"	CVX-12	1/4" Heavy duty	1/4" Male flare x 3/4" NPS	4000 psi (276 bar)	800 psi (55 bar)	-22 to 176 (-30° to 80°C)	6" (152 mm)
18912	12"	CVY-12	3/8" Heavy duty	3/8" Male flare x 3/4" NPS	3000 psi (207 bar)	600 psi (41 bar)	-22 to 176 (-30° to 80°C)	8" (203 mm)
18072	72"	CVH-72	1/4" Original	1/4" Female flare x 3/4" NPS	2500 psi (172 bar)	500 psi (34 bar)	-20 to 180 (-28.8° to 82.2°C)	6" (152 mm)
18372	72"	CVB-72	3/8" Standard	3/8" Female flare x 3/4" NPS	3000 psi (207 bar)	600 psi (41 bar)	-20 to 200 (-28.8° to 93.3°C)	6" (152 mm)

## FUEL OIL ASSEMBLY HOSES

Reinforced hose designed for quick pump to nozzle connection and oil burner connections.

- Flexible to absorb vibration and swelling while providing positive cut-off
- 4000 psi (276 bar) minimum burst and 800 psi (55 bar) maximum working pressure
- Operating temperature -20° to 180°F (-28.8° to 82.2°C)
- Minimum bend radius: 6" (152 mm)
- Made in the USA



UPC#	Length	Description
78041	12"	3/16" Female flare x 3/16" Female flare Pump to nozzle connector
78042	12"	1/4" Female flare x 1/4" Female flare Pump to nozzle connector
78112	12"	1/8" NPT Female swivel x 1/8" NPT Male Pump to nozzle connector or gauge to pump
78043	18"	3/16" Female flare x 3/16" Female flare Pump to nozzle connector
78044	18"	1/4" Female flare x 1/4" Female flare Pump to nozzle connector

Longer lengths available.

## OIL PUMP VIBRATION ELIMINATOR

Reinforced rubber hose helps eliminate noise and vibration when installed in a heating system.

- 3000 psi (207 bar) minimum burst, 600 psi (41 bar) maximum working pressure
- Operating temperature -20° to 180°F (-28.8° to 82.2°C)
- Minimum bend radius: 6" (152 mm)
- Made in the USA



UPC#	Length	Description
78012	12"	3/8" Male flare x 1/4" NPT Male oil burner connector

UPC#	Description
19020	Replacement gasket for 1/4" and 1/2" Acme hose (10 pak)
18001	Cylinder gasket (10 pak)

Use cylinder valve adapters only. See page 33.



# HIGH PRESSURE CONTROL HOSE

For HFC, HCFC and CFC refrigerants and hydrocarbons



The YELLOW JACKET® pressure control hose is constructed of a thermoplastic polymer inner tube and cover. This new material eliminates the vibration problems that are present in copper capillary tube installations.

The higher temperature ratings of this thermoplastic to 266° F eliminate the failures caused by maximum load conditions on rubber type pressure control hoses.

Between the inner tube and the cover, the hose is reinforced with a polyester braid of high tensile strength with high modulus, giving it the ability to withstand higher pressures.

Available in any combination of 1/4" or 3/8" brass SAE flare straight or 90° angle fittings. Hex nuts are brass. Copper gaskets provide the best possible seal.

- Improved permeation characteristics. R-134a permeation tested at: 0.188 oz./ft./yr. 0.0118 lb./ft./yr 17.6 gr./m./yr.
- Results with other refrigerants will also show superior performance characteristics
- For use with most HFCs such as R-134a, R-404A, R-407A, R-407B, R-407C, R-410A and R-507, HCFC such as R-22, HC's, R290 and R600A
- Usable oil types include polyol ester, alkylbenzene and mineral oils.

Specifications	
I.D.:	.156" (4.0 mm)
O.D.:	.325" (8.2 mm)
Working pressure:	800 psi, 55 bar, 5.5 MPa
Burst pressure:	4000 psi, 276 bar, 27.6 MPa
Minimum temperature:	-49° F (-44° C)
Maximum temperature:	266° F (130° C)

Length* (assembly)	UPC#				
	1/4" Str. x Str.	1/4" Str. x 90°	1/4" 90° x 90°	3/8" Str. x Str.	3/8" Str. x 90°
12"	78612	78712	78812	78912	79112
18"	78618	78718	78818	78918	79118
24"	78624	78724	78824	78924	79124
30"	78630	78730	78830	78930	79130
36"	78636	78736	78836	78936	79136
48"	78648	78748	78848	78948	79148
60"	78660	78760	78860	78960	79160
72"	78672	78772	78872	78972	79172
96"	78696	78796			

\* Special lengths are readily available.



CHARGING SYSTEMS  
 GAUGES  
 RECOVERY MACHINES  
 VACUUM PUMP SYSTEMS  
**VACUUM AND CHARGING HOSES**  
 HOSE ADAPTERS, VALVES & PARTS  
 WIRELESS AND ELECTRONIC INSTRUMENTS  
 LEAK DETECTORS AND MONITORS  
 HEATING INSTRUMENTS  
 SYSTEM TOOLS

# STAINLESS STEEL HOSE SPECIFICATIONS

YELLOW JACKET stainless steel assemblies are 300 series corrugated hose and braid for applications where temperature and pressure could be a problem.

With stainless steel braid wrapping a stainless steel core, all hoses on this page prevent permeation and moisture infusion. Use with all standard refrigeration oils and refrigerants, as well as the new alternative oils and refrigerants including R-123.

Applications: vacuum and charging, vibration isolation, movable components and permanent application. **Not for use with NH<sub>3</sub>.**

Standard and custom length assemblies are made to order. Minimum length 12."

Stainless steel hose specifications				
Size	Max psi working*	Flexing bend radius	Permanent bend radius	Temperature/pressure correction
1/4"	1275 (88 bar)	5.5"	1"	68°F - 1.00 200°F - .86 300°F - .80
3/8"	1000 (69 bar)	6.5"	1-1/4"	400°F - .78 500°F - .77
1/2," 5/8"	1000 (69 bar)	8.5"	1-1/2"	800°F - .76 900°F - .74
3/4"	725 (50 bar)	10"	2"	1000°F - .70
1"	700 (48 bar)	11.5"	2-3/4"	
1-1/4"	550 (38 bar)	13"	3-1/4"	

\* PSI at 68°F with a 4-to-1 safety factor. Core is T-321 SS with 300 Series SS braid.

## QUICK COUPLER ASSEMBLY

### For vacuum and charging

Oversized to increase flow and speed evacuation. Pull 25 microns and better on 36" length.

- Brass quick coupler
- Standard 45° angle at one end on 1/4" and 3/8" (90° available)
- Straight fittings only on 1/2", 5/8" and 3/4"
- Made in the USA 



Length	Str. x 45° 1/4" I.D.	Str. x 45° 3/8" I.D.	Str. x Str. 1/2" I.D.	Str. x Str. 5/8" I.D.	Str. x Str. 3/4" I.D.
36"	81636	81736	81836	81936	82036
48"	81648	81748	81848	81948	82048
60"	81660	81760	81860	81960	82060

## SWEAT FITTING ASSEMBLY



Female sweat fitting		Male sweat fitting	
86136	1/4" x 36"	85136	1/4" x 36"
86236	3/8" x 36"	85236	3/8" x 36"
86336	1/2" x 36"	85336	1/2" x 36"
86436	5/8" x 36"	85436	5/8" x 36"
86536	3/4" x 36"	85536	3/4" x 36"
86636	7/8" x 36"	85636	7/8" x 36"
86736	1-1/8" x 36"	85736	1-1/8" x 36"
86836	1-3/8" x 36"	85836	1-3/8" x 36"

Manufactured with straight, copper sweat ends.

- Male sweat to fit inside mating tube
- Female sweat to fit outside mating tube
- Made in the USA 

## FLARE ASSEMBLY

### For display cases, etc.



Stainless steel assemblies are made with a combination of Male and Female flares. Custom assemblies can be made.



Fl. size x length	Male fl. x Male fl.	Male fl. x Fe. fl.	Fe. fl. x Fe. fl.
1/4" x 36"	82136	83136	84136
1/4" x 48"	82148	83148	84148
3/8" x 36"	82236	83236	84236
3/8" x 48"	82248	83248	84248
1/2" x 36"	82336	83336	84336
1/2" x 48"	82348	83348	84348
5/8" x 36"	82436	83436	84436
5/8" x 48"	82448	83448	84448
3/4" x 36"	82536	83536	84536
3/4" x 48"	82548	83548	84548

NOTE: Stainless steel hoses are made-to-order and cannot be returned.

NOTE: Custom lengths are available for all stainless steel hose assemblies on this page.

## GET MAXIMUM BENEFIT FROM YOUR YELLOW JACKET METAL HOSES

Keep your hoses on the job longer and the YELLOW JACKET warranty in effect by avoiding sharp bending and twisting that causes early failure. The warranty does not cover fatigue failure. Replace gaskets in quick couplers as needed to ensure a proper sealing.

CHARGING SYSTEMS  
RECOVERY MACHINES  
VACUUM PUMP SYSTEMS  
VACUUM AND CHARGING HOSES  
HOSE ADAPTERS, VALVES & PARTS  
WIRELESS AND ELECTRONIC INSTRUMENTS  
LEAK DETECTORS AND MONITORS  
HEATING INSTRUMENTS  
SYSTEM TOOLS

## CO<sub>2</sub> TEST AND CHARGING MANIFOLD

Manifold and hoses designed specifically for transcritical CO<sub>2</sub> (R-744) applications.



The YELLOW JACKET® TITAN® Test and Charging Manifold for transcritical CO<sub>2</sub> systems is constructed with a forged aluminum alloy body making it lightweight for handling ease and durability. No sightglass means added safety. It features true 45° SAE flare hoses 78" in length.

- Large, easy-to-read 3-1/8" (80 mm) liquid-filled red and blue, 1% accuracy (Class 1) gauges; psi/bar
- Proven, double "O"-ring piston for reliability and long service life.
- Exclusive 100 mesh filter in-line on all flare fittings helps keep out particulate material and extends the life of the seats.
- Fourth hose to enable connection to hi/lo sides, refrigerant tank, and vacuum pump for diagnostics, evacuation and charging without switching hoses.
- 3/8" vacuum port for use with larger hose to cut evacuation time by up to 33% (all other fittings on unit are 1/4").
- Dedicated transcritical CO<sub>2</sub> hose 78" (200 cm) in length
- Designed and assembled in the USA 

### Specifications

Scales:	LP 30 in. Hg/1500 psi (-1/+105 bar) -60° to 85°F (-52° to 30°C) HP 0/3000 psi (0/210 bar)
4-valve forged aluminum body	
Precision stainless steel valve feed screws	
No sight glass for added safety	
Class 1, 3-1/8" (80 mm), oil-filled, pulse-free	
Fittings:	(3) 1/4"; (1) 3/8" (vacuum application only)
Hoses:	Three (3) black, 78" (200 cm), 1/4" SAE fittings (45°) <ul style="list-style-type: none"> <li>• Operating pressure 1740 psi (120 bar)</li> <li>• High pressure copper gaskets</li> </ul> One (1) yellow, 78" (200 cm), 3/8" SAE fittings <ul style="list-style-type: none"> <li>• Operating pressure 594 psi (41 bar)</li> <li>• Neoprene built-in gaskets</li> </ul>

UPC#	Description
45925	TITAN® CO <sub>2</sub> Manifold with hoses (3) black and (1) yellow
45922	CO <sub>2</sub> 78" (200 cm) black replacement hose (single)
45923	Nylon CO <sub>2</sub> Manifold bag with handle and straps (optional)
14579	3/8" 78" (200 cm) yellow replacement hose (single)
49193	High pressure replacement gauge
49194	Low pressure replacement gauge
79472	1/4" STR X 45° CO <sub>2</sub> Hose 72"
79510	1/4" STR X 45° CO <sub>2</sub> Hose 120"



# HOSE ADAPTERS, VALVES AND PARTS

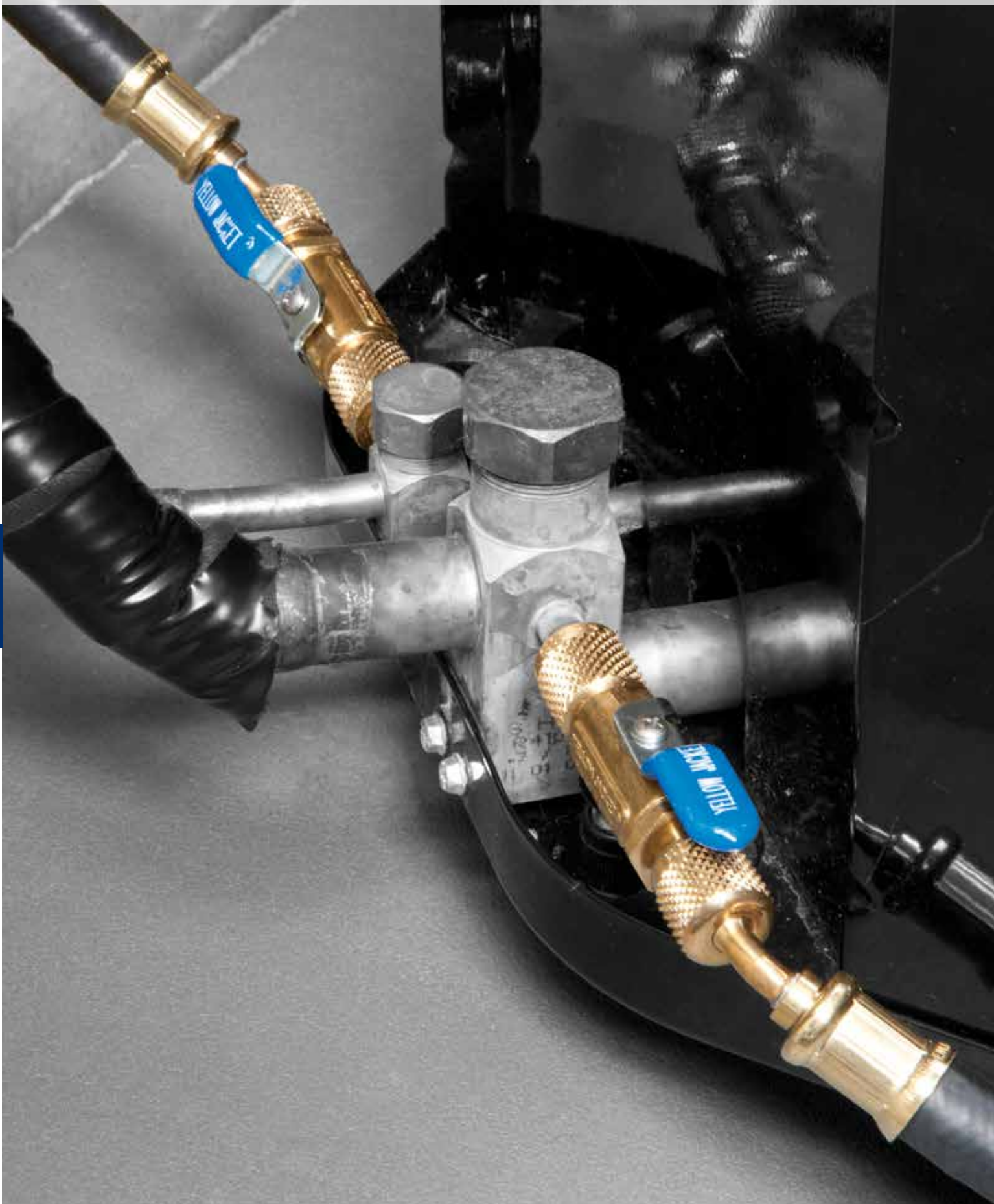

## 1/4" 4-IN-1 BALL VALVE TOOL

For vacuum, charge, cores and recovery



Remove and replace Schrader cores without losing charge.

- Extra 1/4" side port on 18975 to attach electronic micron vacuum gauge right at system for greater accuracy or to add refrigerant
- Evacuate and charge through an unrestricted line for increased speed and higher vacuum
- Core removal allows recovery unit to work at maximum efficiency, speeding the recovery process



UPC#	Description
18975	Vacuum/charge valve with side port
18971	Vacuum/charge valve without side port
18980	Accessory set - 2 piece
18978	Schrader rethreading accessory
18979	Broken Schrader remover accessory
18983	Quad rings (10 pak)
18997	Grappler rod/nut assembly
18973	Gasket for 18975 (5 pak)
18974	Seal kit includes core, cap, 4 "O" rings, gasket
19305	Schrader cores (10 pak)

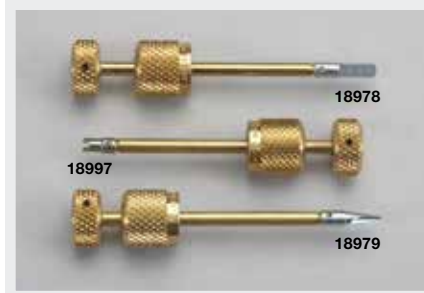

## 5/16" 4-IN-1 BALL VALVE TOOL

For R-410A systems with 5/16" access ports



Similar to the 1/4" 4-in-1 core tool but with 5/16" flare fittings. For use with R-410A systems and mini splits with larger 5/16" service ports.



UPC#	Description
18985	5/16" Vacuum/charge valve with side port
18981	5/16" Vacuum/charge valve without side port
18987	5/16" Grappler rod/nut assembly
18988	5/16" Rethread accessory
18989	5/16" Schrader remover
18984	Seal kit includes core, cap, 4 "O" rings, gaskets
19173	5/16" Quick coupler x 1/4" MFL Schr
19305	Schrader cores (10 pak)
18986	1/4" Male x 5/16" female vacuum/charge valve
18973	Gasket for 18975 (5 pak)

## COMPACT BALL VALVES

1/4" and 5/16"



Compact ball valves feature full flow for charging and recovery. Metal valve handle.

- 1/4" ball valves are UL recognized to 4000 psi (276 bar) minimum burst, 800 psi (55 bar) maximum working pressure
- 5/16" for R-410A applications where 5/16" system ports are used
- 5/16" are UL recognized to 4000 psi (276 bar) minimum burst, 800 psi (55 bar) maximum working pressure



UPC#	Description
93844	1/4" Compact ball valve – straight
93843	1/4" Compact ball valve – 45°
93842	1/4" Compact ball valves – 45° (3 pak)
93825	5/16" Compact ball valve for 5/16" Female flare x 1/4" Male flare-45°
93826	5/16" Compact ball valve for 1/4" Female flare x 5/16" Male flare
93827	5/16" Compact ball valve for 5/16" Female flare x 5/16" Male flare

## FULL CONTROL BALL VALVES FOR VACUUM/CHARGING



When building your own charging/vacuum system, these straight flow-through valves connect hoses and provide full-flow capacity.

- No angles to cause restrictions and pressure drops
- Handle position shows when the valve is opened or securely closed



	M. fl. x M. fl.	M. fl. x 1/4" FPT	M. fl. x Fe. fl.	Gaskets
1/4" SAE*	93834	93833	93844	19020
5/16" SAE	–	–	93827	19020
3/8" SAE*	93836	93832	93846	19011
1/2" SAE	93838	–	93848	19015
1/2" Acme*	93830	93831	93840	19020
19095	Replacement handle/screw for all 1/4", 3/8" and Acme valves (2 pc. set)			
19096	Replacement handle/screw for all 1/2" flare valves (2 pc. set)			

\* UL Listed

CHARGING SYSTEMS  
GAUGES  
RECOVERY MACHINES  
VACUUM PUMP SYSTEMS  
VACUUM AND CHARGING HOSES  
HOSE ADAPTERS, VALVES AND PARTS  
WIRELESS AND ELECTRONIC INSTRUMENTS  
LEAK DETECTORS AND MONITORS  
HEATING INSTRUMENTS  
SYSTEM TOOLS

## GAS RETENTION VALVE

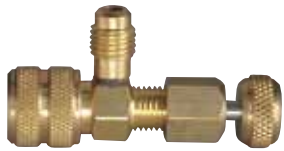

- Valve controls refrigerant flow from access fitting
- Closes Schrader before disconnecting
- Back seat valve feature to retain gas in hose when disconnecting
- 1/4" Female flare x 1/4" Male flare
- 500 psi working pressure
- Made in the USA

UPC#	Description
18993	Core depressor valve
18995	"O" ring set

## VACUUM/CHARGE VALVE



1/4" vacuum/charge valve with or without side port. For faster vacuum/charging or removing/replacing Schrader cores.



UPC#	Description
18990	Vacuum/Charge valve with side port
19000	Vacuum/Charge valve

Replacement parts	
18995	"O" ring set
18996	Shut-off stem
18997	Grappler rod/nut assembly

## QUICK COUPLER-STYLE BRAZE-IN FITTINGS

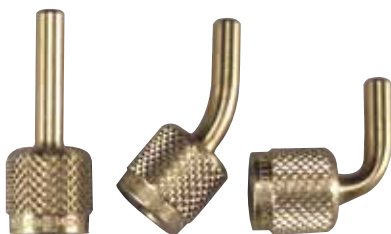

Braze-in brass fitting with replaceable soft seat. Quick coupler-style fittings are the same as supplied on metal hose.

UPC#	Description
19082	1/4" Str. Female fl. with CH20 gasket
19083	1/4" 45° Female fl. with CH20 gasket
19084	1/4" 90° Female fl. with CH20 gasket
19085	3/8" Str. Female fl. with quad ring
19086	3/8" 45° Female fl. with quad ring
19087	3/8" 90° Female fl. with quad ring
19088	1/2" Str. only Female with CH80 gasket

Use 19015 (CH80), 19020 (CH20) and 19026 (quad ring) seals.

## VALVE CORE TOOL



Self contained tool for quickly removing and replacing cores. Handle contains six cores.

UPC#	Description
19306	Valve core tool
19305	Schrader valve (10 pk)

## 125 AND 145 LB. CYLINDER VALVE ADAPTER



Finger tight adapters fit 125 and 145 lb. cylinders. Seal remains seated.

UPC#	Description
19105	3/4" NPS cylinder adapter with 1/4" Male flare
19106	3/4" NPS cylinder adapter with 3/8" Male flare
18001	Replacement gasket (10 pak)

## VACUUM PUMP INTAKE ADAPTER



Reducing adapter for pump intakes on SUPEREVAC™ and other vacuum pumps.

UPC#	Description
19130	3/8" Fe. fl. x 1/4" M. fl. adapter
19131	1/2" Fe. fl. x 3/8" M. fl. adapter
19132	1/2" Fe. fl. x 1/4" M. fl. adapter
19160	1/2" Fe. fl. x 1/2" M. Acme adapter
19133	3/8" Fe. fl. x 1/2" M. fl. adapter

## VACUUM PUMP ADAPTER



Convert a 3/8" or 1/2" vacuum pump intake into 1/4" and 1/2" Acme R-134a compatible fittings.

UPC#	Description
36018	1/2" Pump adapter with 1/4" flare and 1/2" Acme Male fittings
36019	3/8" Pump adapter with 1/4" flare and 1/2" Acme Male fittings

## MODIFIED NEEDLE VALVE In-line control



UPC#	Description
69670	Needle type bleed valve 1/4" flare

## MANIFOLD PARTICULATE FILTER



Manifold particulate filters trap particles before they damage valve seats or pass into recovery equipment. Screens are replaceable and cleanable.

UPC#	Description
41119	1/4" Manifold particulate filter
41120	3/8" Manifold particulate filter
41121	1/2" Manifold particulate filter
41122	Replacement filter screen (5 pak)

## ADD-A-HOSE COUPLER



Add-a-hose couplers easily connect hoses to the length desired.

UPC#	Description	UPC#	Description
19143	3/16" Male flare	19150	5/8" Male flare
19144	1/4" Male flare	19152	3/4" Male flare
19146	3/8" Male flare	19142	1/2" Acme
19148	1/2" Male flare	-	-



# QUICK COUPLERS Expanded line



- Full size with deep knurling for easy handling
- CH14 "Adjust-a-Valve" opener in all 1/4" Female ends
- Acme conversion couplers are available for recovery tank threads and R-134a cylinder threads
- 5/16" Conversion couplers available
- Made in the USA

UPC#	Description
<b>Straight quick couplers</b>	
19125	1/8" Female QC x 1/4" Male flare (Ford)
19120	3/16" Female QC x 1/4" Male flare (GM)
19101	1/4" Female QC x 1/4" Male flare
19102	1/4" Female QC x 3/8" Male flare
19111	1/4" Female QC Str. x 1/8" NPT Male
19116	1/4" Female QC Str. x 1/4" NPT Male
19103	3/8" Female QC x 3/8" Male flare
19104	3/8" Female QC x 1/4" Male flare
19115	1/2" Female QC x 3/8" Male flare
19114	3/8" Female QC x 1/2" Male flare
19020	Gaskets (10 pk)

UPC#	Description
<b>90° Quick couplers</b>	
19220	3/16" Female QC 90° x 1/4" Male flare
19201	1/4" Female QC 90° x 1/4" Male flare
19202	1/4" Female QC 90° x 3/8" Male flare
19203	3/8" Female QC 90° x 3/8" Male flare
19214	3/8" Female QC 90° x 1/2" Male flare

<b>Gauge quick couplers with CH14 adjustable valve opener</b>	
19110	1/4" Female QC x 1/8" NPT Fe.
19118	1/4" Female QC Str. x 1/4" NPT Fe.
19210	1/4" Female QC 90° x 1/8" NPT Fe.
19218*	1/4" Female QC 90° x 1/4" NPT Fe.

<b>5/16" Quick couplers with CH14 adjustable valve opener</b>	
192121*	5/16" QC Str. x 1/4" Male flare
19221*	5/16" QC 90° x 1/4" Male flare
192122*	1/4" QC Str. x 5/16" Male flare
19222*	1/4" QC 90° x 5/16" Male flare

<b>ACME 1/2" couplers – auto straight</b>	
19161	1/4" Female QC x 1/2" Acme Male
19162	1/4" Female hex x 1/2" Acme Male for permanent applications
19166	1/2" Acme Male x 1/2" Acme Female
19165	1/2" Acme Female x 1/4" Male flare
19168	1/2" Acme Female x 1/8" NPT Male
19158	1/2" Acme Female x 14 mm Male

\* Not pictured

- All couplers have Schrader valve cores in Male flare end
- Female coupler end has deep knurling for easy handling
- Patented CH14 "Adjust-a-Valve" opener in all 1/4" Female ends
- Made in the USA

UPC#	Description
<b>Straight quick couplers</b>	
19171	1/4" Female QC x 1/4" Male flare
19172	3/8" Female QC x 1/4" Male flare

<b>90° Bend quick couplers</b>	
19191	1/4" Female QC x 1/4" Male flare
19192	3/8" Female QC x 1/4" Male flare

<b>45° R-410A couplers</b>	
19173	5/16" Female QC x 1/4" Male flare
19174	1/4" Female QC x 5/16" Male flare
19175	5/16" Female QC x 5/16" Male flare

## QUICK COUPLERS Schrader core in male end



## SEALRIGHT™ QUICK COUPLERS



SealRight fittings automatically and immediately trap refrigerant in the hose when disconnected, helping meet non-venting regulations and preventing finger burns. One-piece attaches quickly, saving up to 50 percent in time compared to 2-piece quick couplers.

- Works with or without Schrader core
- Gaskets resist deterioration from SealRight repair assembly components
- CFC, HCFC, HFC refrigerants and refrigerant oils. Field serviceable
- Made in the USA

UPC#	Description
19109	1/4" SealRight Str. x 1/4" Male flare
19208	1/4" SealRight 45° x 1/4" Male flare
19209	1/4" SealRight 90° x 1/4" Male flare
19100	Set of 19109 and 19209
19117	1/4" SealRight Str. x 3/8" Male flare
19217	1/4" SealRight 90° x 3/8" Male flare
19128	1/4" SealRight Str. x 1/8" NPT Female
19129	1/4" SealRight Str. x 1/4" NPT Female
19169	Acme 1/2" SealRight x 1/2" Acme
19163	Acme 1/2" SealRight x 1/4" Male flare

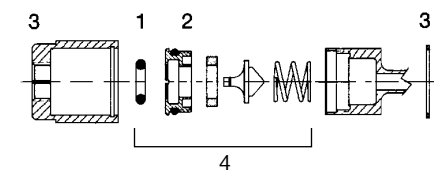

UPC#	Description
<b>SealRight repair assembly components</b>	
19037	"O" rings (10 pak) (1)
19038	Plug assembly with all seals (2)
19039	Nut and clip (3)
19040	Rebuild kit (4)
19041	Overhaul kit with all above parts
19045	Gasket set

CHARGING SYSTEMS  
GAUGES  
RECOVERY MACHINES  
VACUUM PUMP SYSTEMS  
VACUUM AND CHARGING HOSES  
HOSE ADAPTERS, VALVES AND PARTS  
WIRELESS AND ELECTRONIC INSTRUMENTS  
LEAK DETECTORS AND MONITORS  
HEATING INSTRUMENTS  
SYSTEM TOOLS

## SINGLE VALVES



- Individual manifolds for hi- and lo-sides of system
- Individual valves are available in two or three port versions
- Nylon seals with double “O” rings
- Made in the USA 

UPC#	Description
40317	High-side manifold with gauge
40318	Low-side manifold with gauge and hook
40315	2 Port valve – 1/8" NPT Female x 1/4" Male flare
40325	3 Port valve – 1/8" NPT Female x 2 1/4" Male flares
40350	2 Port valve – 1/4" QC Female with CH14 depressor x 1/4" Male flare with Schrader
40326	Low-side 1/4" valve for R-32 and R-410A
40338	Low-side manifold R600A
40339	High-side manifold R600A/600/290
40340	Low-side manifold R600A/600/290

## QUICK COUPLER GASKETS AND “O” RINGS

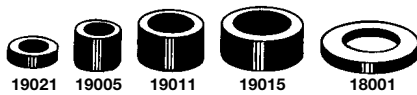

The only gaskets designed for optimum performance with YELLOW JACKET Charging Hoses. Works with all refrigerants. Manufactured to strict tolerances to resist blow out.

UPC#	Gasket/Part	Quantity	Application
19020	CH20/10	10	1/4" Hose 5/16" Hose 1/2" Acme hose
19005	CH20/100	100	1/4" Hose
19011	CH11	10	3/8" Hose
19015	CH80	10	1/2"-5/8" Hose
19012	E hose	10	3/4" Hose
18001**		10	Cylinder valve
19021	1/8" Gasket	10	1/8" Coupler
19022		5	60667 Recovery pliers
19010	CH20 and CH14	6 3	1/4" Hose opener
UPC#	“O” ring	Quantity	Application
19026*	–	10	3/8" Quad ring
19034	–	10	“O” ring for 14 mm Male
19037	–	10	1/4" SealRight “O” ring
UPC#	Description		
59651	1/4" Copper gaskets (10 pak)		
59652	3/8" Copper gaskets (10 pak)		
59653	1/2" Copper gaskets (10 pak)		
59654	5/8" Copper gaskets (10 pak)		
59655	3/4" Copper gaskets (10 pak)		

\* Gaskets for some metal hose sizes. Others use 19020 or 19011 gaskets.  
\*\*Flat washer.

## PARTS KITS AND EMPTY BOXES



The 19003 complete kit includes the following gaskets, valve openers and SealRight parts in a 12 compartment case.

- Five 1/8" gaskets
- Five 1/8" valve openers
- One hundred 3/16"-1/4" gaskets
- Ten 1/4" Adjust-a-Valve openers
- Ten 1/4" flat valve openers
- Ten 3/8" gaskets
- Ten 1/2"-5/8" gaskets
- Ten cylinder valve flat gaskets
- Ten SealRight “O” rings
- Four SealRight plug and seal assemblies
- Four 1/4" SealRight nut and clip
- Made in the USA 

UPC#	Description
19003	Complete kit
19004	11" x 6-3/4" x 3/4" Kit box with parts label
60178	11" x 6-3/4" x 3/4" 12 Compartments empty
60135	11" x 6-3/4" x 3/4" 18 Compartments empty

## “ADJUST-A-VALVE™” OPENERS

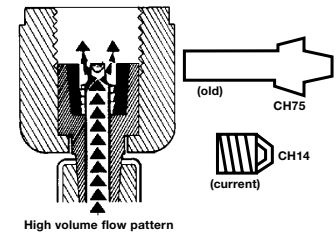

The patented “Adjust-a-Valve” reaches out-of-tolerance Schrader valves in 1/4", 3/16" and 5/16" couplers. Simply rotate the opener with needle nose pliers to the desired height and when finished, rotate it back. “Adjust-a-Valve” for 1/4" and 5/16" hoses is the same.



UPC#	Description
19302	“Adjust-a-Valve” openers (10 pak)
19301	1/4" Valve openers (10 pak)
19304	1/8" Valve openers (10 pak)

## GASKET REMOVER PICK

Easily remove worn gaskets from hoses and replace with new gaskets. Sharp, angled pick is long enough to pull the gasket from deep inside the hose. Notch on the opposite end of the pick for placing the depressor inside the hose. Pick stores inside case along with five CH20 gaskets (included) for protection and safety.



UPC#	Description
19047	Gasket Remover Pick (Individual)
19048	Counter Display (12 pak)

## AUTOMOTIVE R-134a A/C COUPLERS

Premium with control valve



Couplers interface with R-134a service ports. 14 mm Female thread or 1/4" Male flare available.

- Quick, easy connect/disconnect
- Control valve for access to systems even at working pressures
- Integral safety sleeve holds coupler securely to service port
- Highest flow characteristics
- Low profile for tight applications



UPC#	Description
41301	Chrome hi-side x 14 mm R-134a coupler
41302	Chrome lo-side x 14 mm R-134a coupler
41327	Hi-side x 3/8" Male fl., R-134a coupler
41328	Lo-side x 3/8" Male fl., R-134a coupler
41337	Hi-side x 1/4" Male fl., R-134a coupler
41338	Lo-side x 1/4" Male fl., R-134a coupler
41300	Replacement "O" rings (2 pak)

## LIQUID CHARGING ADAPTER

Convert liquid to saturated vapor



Liquid charging is recommended when charging blends into refrigeration and air conditioning systems. A liquid charging adapter is necessary for safe and fast liquid (saturated vapor) charging through the low pressure side of a system. The YELLOW JACKET liquid charging adapter connects to the cylinder valve or refrigerant tank.

- To protect the compressor, adapter orifice reduces liquid flow to a level below compressor capacity
- Refrigerant flashes off into a saturated vapor to speed entry
- Eliminates the time and work of heating cylinders
- Made in the USA

UPC#	Description
41123	1/4" Liquid charging adapter
41124	5/16" Liquid charging adapter
41132	Replacement "O" ring/orifice for 1/4" adapter
41138	Replacement "O" ring/orifice for 5/16" adapter

## AUTOMOTIVE R-134a ECONOMY A/C COUPLERS



A basic R-134a service coupler with no control valve. Snaps on for instant flow.

UPC#	Description
41318	Lo-side coupler with 1/4" flare
41317	Hi-side coupler with 1/4" flare
41305	Replacement "O" ring set (6 pak)

## AUTOMOTIVE 1234YF A/C COUPLERS



- Couplers interface with 1234yf service ports.
- M12x1.5-6H Female thread
- Quick, easy connect/disconnect
- Meets SAE J639

UPC#	Description
41441	1234yf hi-side coupler, 14mm
41442	1234yf lo-side coupler, 14mm

## AUTOMOTIVE A/C FITTINGS COUPLERS



Adapter fittings designed to work with 1/2" Acme or 14 mm threads.

UPC#	Description
19157*	14 mm Male x 1/4" Male flare
19156*	14 mm Male x 3/8" Male flare
19161	1/2" Acme Male x 1/4" Female flare
19165	1/2" Acme Female x 1/4" Male flare
19158	1/2" Acme Female x 14 mm Male
19162	1/2" Acme Male x 1/4" Female flare hex
19168	1/2" Acme Female x 1/8" Male pipe
19169	1/2" Acme Male x 1/2" Acme SealRight
19163	1/2" Acme SealRight x 1/4" Male flare
19166	1/2" Acme Female x 1/2" Acme Male
40265	1/2" Acme Male x 1/8" NPT Male half union
19142	1/2" Acme union
19153*	1/2" Acme Female hex x 13 mm R-134a lo-side Male for A/C system

\* Not pictured

CHARGING SYSTEMS  
GAUGES  
RECOVERY MACHINES  
VACUUM PUMP SYSTEMS  
VACUUM AND CHARGING HOSES  
HOSE ADAPTERS, VALVES AND PARTS  
WIRELESS AND ELECTRONIC INSTRUMENTS  
LEAK DETECTORS AND MONITORS  
HEATING INSTRUMENTS  
SYSTEM TOOLS



# WIRELESS AND ELECTRONIC INSTRUMENTS



CHARGING  
SYSTEMS

GAUGES

RECOVERY  
MACHINES

VACUUM PUMP  
SYSTEMS

VACUUM AND  
CHARGING HOSES

HOSE ADAPTERS,  
VALVES & PARTS

WIRELESS AND  
ELECTRONIC  
INSTRUMENTS

LEAK DETECTORS  
AND MONITORS

HEATING  
INSTRUMENTS

SYSTEM TOOLS



## Wireless and Electronic Instruments

Convenient wireless measurements for complete HVAC/R diagnostics.





CHARGING SYSTEMS  
GAUGES  
RECOVERY MACHINES  
VACUUM PUMP SYSTEMS  
VACUUM AND CHARGING HOSES  
HOSE ADAPTERS, VALVES & PARTS  
WIRELESS AND ELECTRONIC INSTRUMENTS  
LEAK DETECTORS AND MONITORS  
HEATING INSTRUMENTS  
SYSTEM TOOLS



**YJACK® WIRELESS SENSORS AND P51-TITAN MANIFOLD - SEE PAGES 7-12**

**WIRELESS REFRIGERANT CHARGING SCALE**



**Convenient Wireless Measurements!**

With a 220 lb. capacity, large platform and wireless Bluetooth® communication, this accurate scale makes refrigerant charge measurements fast and easy. Just connect with any smart device and you are ready to go...with .05% accuracy and 0.2 oz. resolution, service technicians can count on precision measurements every time. Save the charging measurements to your smart device, and you have a permanent record for that installation or service call.

**Features and Benefits**

- Low Energy Bluetooth® communication
- Lightweight, durable design
- Stability control for accurate measurements
- 220 lb. (100kg) capacity
- 0.05% accuracy & 0.2 oz. resolution
- Overload protection
- Oversized platform (12 in./300mm)
- Integrated handle
- Carrying case included
- 9V battery included
- One-year warranty



The Wireless Refrigerant Scale 68864 is controlled and operated with any Smart Device via Bluetooth®. Search for the YJScale app.

**READINGS SCREEN OVERVIEW**

Press for calibration with known weight

Press to add comments that will appear on the saved screenshots

Scale weight stability indicator

Press to power off scale (when connected)

Press to change weight units between lb/oz & kg

Press to take a screenshot of scale readings and comment

Press to scan for available scales

Weight reading status, run or hold

Scale battery level

Press to zero out the scale reading

Press to hold the displayed weight reading

**Specifications**

Weight Capacity:	220 lb. / 100 kg
Overload Protection:	Yes
Measurement Units:	Pounds and ounces (lb & oz) or kilograms (kg)
Reading Accuracy:	0.05% of reading
Reading Resolution:	5g
Operating Temperature:	32°F - 122°F (0°C - 50°C)
Scale Platform Diameter:	11.8 in (300mm)
Scale Weight:	6.4 lb. (2.9 kg)
Power:	9V battery (included)
Battery Life:	40+ hours
App OS Compatibility:	iOS or Android
Bluetooth® Technology:	Bluetooth® Low Energy (BLE)

UPC#	Description
68864	Wireless refrigerant scale, 220 lb.



## REFRIGERANT CHARGING SCALE



### *Accurate, compact and economical!*

With a 220 lb. capacity and solid accuracy, this compact YELLOW JACKET® charging scale can handle the job, no matter what the size. Service technicians can count on precise information while on the job with 0.05% accuracy and 0.17 oz. resolution.

#### Features and Benefits

- Compact and lightweight
- Rugged, low profile design
- Maximum weight: 220 lb. (100 kg)
- Large, backlit LCD
- Control module with six foot cord stores under the scale when not in use
- Stability indicator shows when the scale is ready to take a reading
- Over-range indicator
- Auto power off
- Long battery life – 40 hours continuous battery life
- Battery life indicator

#### Specifications

Weight Capacity:	220 lb. / 100 kg
Resolution:	0.17 oz. / 0.011 lb. / 5g
Accuracy:	±0.05% of reading + 10g
Display:	05" (1.27 cm) LCD (7-segment)
Readout Options:	Lbs. / oz. / kg
Overall Size:	10.6" x 10.6" x 2.9" (27.1 cm x 27.1 cm x 7.4 cm)
Overall Weight:	8 lbs. (3.6 kg)
Battery Type:	5 x 1.5V AAA alkaline batteries
Battery Life:	40 hours continuous
Warranty:	1 year
Operating Temperature:	14° F to 104° F (-10° C to 40° C)
Temperature Fluctuation Range:	41° F / hr. (5° C)
Storage Temperature:	5° F to 122° F (-15° C to 50° C)
Relative Humidity:	50 - 85%

### *Control module stores inside the platform when not in use.*



UPC#	Description
68862	220 lb. charging scale with bag

## DIGITAL ELECTRONIC CHARGING SCALES

Electronic charging scales show the progress of the charge as it's happening, indicating when to close the valves and stop the charge. Works with any refrigerant in any system.

- Calibration standards traceable to NIST
- Removable control module on retractable 5' coiled cord
- Mechanical overload protection and "OL" alert on LCD
- Industrial grade circuitry for long life performance
- Minus (-) reading shows weight removed from the platform

- Single point load cell strain gauge for long-term stability and accuracy



Full bridge configuration with four strain gauges for accuracy.

Programmable electronic charging scales have added capabilities for automated, faster and more economical charging. Simply program the charging weight and the valve will close automatically when the charge is complete.

- Mesh filter in charging module protects solenoid valve from debris
- Low flow triggers automatic hold to extend solenoid life
- Schrader valve prevents backflow through solenoid

- Charging accuracy is equal to scale accuracy +/- 0.25 oz.
- Solenoid valve with 400 psi maximum operating pressure differential (MOPD) allows metering broad range of refrigerants
- Made in the USA 

Convert standard 68802 and 68800 scales to programmable with upgrade kits 68804 and 68805. Each kit includes a charging module, power pack, instruction manual and larger carrying case to hold all parts.



68804



68805



68802

68803

### Specifications

Resolution: 0.1 oz./0.01 lb./0.01 kg  
 Display: Sealed LCD with high resolution 0.5" characters  
 Keypad: Moisture resistant membrane keypad with tactile metal domes  
 Operating temperature range: 32° to 122°F (0° to 50°C)  
 Storage temperature range: -4° to 158°F (-20° to 70°C)  
 Power: 9V battery, battery life approximately 25 hours

### Specifications: 110 lbs. (50 kg) scale

Platform size: 9" x 9" (228 mm x 228 mm)  
 Case size: 15.5" x 12.25" x 3.25" (394 mm x 311 mm x 83 mm)  
 Accuracy: ± 0.5 oz./ ± 0.03 lb./ ± 0.015 kg or 0.1% of reading, whichever is greater  
 Total unit weight: 9 lbs. (4.1 kg)

### Specifications: 220 lbs. (100 kg) scale

Platform size: 11.3" x 11.3" (287 mm x 287 mm)  
 Case size: 18" x 13" x 4.25" (457 mm x 330 mm x 108 mm)  
 Accuracy: ± 1.0 oz./ ± 0.06 lb./ ± 0.03 kg or 0.1% of reading, whichever is greater  
 Total unit weight: 12 lbs. (5.4 kg)

UPC#	Description
68802	Electronic charging scale 110 lbs. (50 kg)
68812	Electronic charging scale 220 lbs. (100 kg)
68803	Programmable electronic charging scale 110 lbs. (50 kg)
68813	Programmable electronic charging scale 220 lbs. (100 kg)
68800	Metric electronic charging scale 50 kg (110 lbs.)
68810	Metric electronic charging scale 100 kg (220 lbs.)
68801	Metric programmable charging scale 50 kg (110 lbs.)
68811	Metric programmable charging scale 100 kg (220 lbs.)
68804	115V Upgrade kit
68805	230V Upgrade kit
68806	115V Adapter
68807	230V Adapter
68818	230V Adapter (UK)
68835	Replacement battery cover (black)
69089	Replacement battery cover (blue)
68808	Charging module



Model 68802 – 110 lbs. (50 kg)  
9" x 9" (228 mm x 228 mm)

Model 68812 – 220 lbs. (100 kg)  
11.3" x 11.3" (287 mm x 287 mm)

# MANTOOTH® WIRELESS VACUUM GAUGE AND P/T GAUGE COMBINATION



The YELLOW JACKET® ManTooth®-PTV (67023) shown above provides vacuum and high- and low-side P/T readings. This full set includes dual non-tethered pressure/temperature gauges, two wired temperature clamps, and one interchangeable vacuum gauge. The single ManTooth® PTV (67021) can be combined with an existing ManTooth® P/T device (67001) for adding wireless vacuum capability and/or expanding it to a full system analysis tool. Simply update your ManTooth® P/T app to version 2.0, connect to the 67020 hardware, and you're ready to go!

To enable mounting on 5/16" systems, add coupler 19221 (90°) or 19121 (straight).



### Product Features:

- Interchangeable/removable vacuum gauge
- Easy-to-clean vacuum sensor
- Built-in Schrader cores for easy refrigerant charging
- Operates with and without hoses attached
- Two year warranty
- High impact glass reinforced housing
- Rechargeable LiPo battery for long battery life
- Robust/rugged vacuum sensor
- Integral magnet for mounting on framework
- Integrated rubber side grip for easy handling

### App Features:

- Available in English, French, Spanish, Dutch, and German.
- Data logging to record and document values during servicing
- Improved connectivity and reconnect process if signal is lost
- Ability to download logged data for graphing in Excel
- For iOS and Android devices
- Backwards compatible with existing ManTooth® Devices (excluding vacuum gauge)

UPC#	Description
67020	ManTooth®-V (Vacuum only) with side grip
67021	ManTooth®-PTV Single with side grip
67023	ManTooth®-PTV Dual with side grip
69030	Vacuum sensor cleaning kit

UPC#	Replacement Parts
67030	Vacuum sensor
67012	USB cord
67014	Carrying case
93394	Tether cap
19020	Hose gaskets (10 pak)
19121	Straight 5/16" Flare quick connect x 1/4" Male coupler
19221	90° 5/16" Flare quick connect x 1/4" Male coupler
19302	Valve depressor (10 pak)
19305	Schrader valve (10 pak)

### Pressure/Temperature Specifications

Pressure Sensing Resolution	0.1 psi, 0.1 bar, 1 kPa, 0.001 MPa, 0.01 kg/cm <sup>2</sup>
Pressure Sensing Accuracy	0.5% of full scale at 25°C; 1% of full scale 55°F to 130°F; 2% of full scale -40°F to 248°F
Working Pressure	0 – 700 psia (48.3 bar)
Proof Pressure	Tolerable pressure without internal damage 1000 psia
Burst Pressure	Tolerable pressure without loss of seal 1500 psia
Temperature Sensor Range (Instrument)	Sensing element: -40°F to 266°F (-40°C to 130°C); Max Cord temp: 176°F (80°C); Max Clamp Temp: 203°F (95°C)
Temperature Display Resolution	0.1°F or °C
Temperature Accuracy (Instrument)	±0.2°C (±0.36°F)
Working Temperature	-4°F to 160°F (-20°C to 71°C) Limited by battery
Storage Temperature	-4°F to 160°F (-20°C to 71°C) - for best battery performance do not store at over 100°F (38°C)
Working Humidity	0-95% RH (non-condensing)
IP Class	IP 50
Bluetooth Range	70-90 ft. (Class 1) or 30-40 ft. (Class 2) in most cases (varies depending on the Bluetooth capability of smart device used). Under perfect conditions (clear line of sight and low interference) communications can extend up to 300 feet.
Bluetooth Radio	Class 1 Bluetooth 2.1 Radio
Size and weight	6" long x 1.6" wide x 2.3" thick (15.3 x 4 x 5.8 cm); 0.5 lbs (225 grams)
Superheat and Subcool	Automatically calculated by the ManTooth® App
Max. and Min. Pressures	Displays and records the maximum and minimum pressures
Refrigerant Database	98 NIST refrigerant profiles included; upgradeable
Screenshot Feature	Save pressure and temperature readings from your sessions; automatically organize
Temperature Sensors	Capable of measuring 2 temperatures using high accuracy NTC thermistors
Pressure Transducers	67001/67003 – one pressure transducer; 67002 – two pressure transducers
System Attachment	Very small internal volume minimizes refrigerant loss during system analysis.
Pressure Zeroing	Simple single button zeroing at the start of each session
Elevation Compensation	Enter elevation at the start of the session for effortless psia compensation
Battery	Rechargeable LiPo battery for 10+ hours continuous life

### Vacuum Specifications

Cord Length	Approximately 33"
Magnet Strength	8 lbs. holding force
Operational Temperature Range	10 – 122F 12 – 50C
Calibration	Calibration standards traceable to NIST
Resolution	.1 micron
Warm-Up Time and Response Time	Instant

CHARGING SYSTEMS  
 GAUGES  
 RECOVERY MACHINES  
 VACUUM PUMP SYSTEMS  
 VACUUM AND CHARGING HOSES  
 HOSE ADAPTERS, VALVES & PARTS  
 WIRELESS AND ELECTRONIC INSTRUMENTS  
 LEAK DETECTORS AND MONITORS  
 HEATING INSTRUMENTS  
 SYSTEM TOOLS



CHARGING SYSTEMS  
GAUGES  
RECOVERY MACHINES  
VACUUM PUMP SYSTEMS  
VACUUM AND CHARGING HOSES  
HOSE ADAPTERS, VALVES & PARTS  
WIRELESS AND ELECTRONIC INSTRUMENTS  
LEAK DETECTORS AND MONITORS  
HEATING INSTRUMENTS  
SYSTEM TOOLS

# MANTOOTH® WIRELESS DIGITAL PRESSURE/TEMPERATURE GAUGE



The YELLOW JACKET® ManTooth® Wireless Digital Pressure/Temperature Gauge provides wireless connection to your smart device so you can test the system without losing refrigerant (no hoses or manifolds necessary)!

The free downloadable ManTooth® RSA app wirelessly calculates and displays the system's actual pressures, temperatures, superheat and subcooling in an easy-to-read color format on your iPhone®, iPad® or Android™ device.

### Additional Features:

- Built-in Schrader ports to easily adjust refrigerant charge
- Range up to 400' (unobstructed)
- YELLOW JACKET® ManTooth® RSA app (free download)
- Two-year warranty
- Screenshot feature allows you to save pressure and temperature readings from your sessions which can be automatically organized by location and unit being serviced
- Share screenshots via e-mail right from your phone
- Easily track and store service history
- Rechargeable lithium polymer battery with 10 hours battery life

The ManTooth® Single Pressure Wireless Digital P/T Gauge includes a single hardware device and clamp. Two single units can be purchased in a case by ordering Part #67003.

For dual pressure readings, use two of the 67001 ManTooth® single pressure gauges or the 67002 ManTooth® Dual Pressure Unit which comes with a P/T module, tether unit and two temperature probe clamps. This unit also includes a convenient carrying case which can be purchased separately for the single pressure unit.

UPC#	Description
67001	ManTooth® Single Pressure Gauge (includes P/T Module with boot, temperature probe clamp, and USB cable)
67002	ManTooth® Dual Pressure Gauge Set (includes P/T Module and tether unit with boots, two temperature probe clamps, and USB cable in case)
67003	Two (2) ManTooth® Single Pressure Gauges (includes two P/T Modules with boots, two temperature probe clamps, and two USB cables in case)
UPC#	Replacement Parts
67010	Clamp
67012	USB Cord
67013	Blue boot
67014	Carrying case
93394	Tether cap
19020	Hose gaskets (10 pak)
19302	Valve depressor (10 pak)
19305	Schrader valve (10 pak)

### Specifications:

Pressure Sensing Resolution	0.1 psi, 0.1 bar, 1 kPa, 0.001 MPa, 0.01 kg/cm <sup>2</sup>
Pressure Sensing Accuracy	0.5% of full scale at 25°C; 1% of full scale 55°F to 130°F; 2% of full scale -40°F to 248°F
Working Pressure	0 – 700 psia (48.3 bar)
Proof Pressure	Tolerable pressure without internal damage 1000 psia
Burst Pressure	Tolerable pressure without loss of seal 1500 psia
Temperature Sensor Range (Instrument)	Sensing element: -40°F to 266°F (-40°C to 130°C) Max Cord temp: 176°F (80°C); Max Clamp Temp: 203°F (95°C)
Temperature Display Resolution	0.1°F or °C
Temperature Accuracy (Instrument)	±0.2°C (±0.36°F)
Working Temperature	-4°F to 160°F (-20°C to 71°C)
Storage Temperature	-4°F to 160°F (-20°C to 71°C)
Working Humidity	0-95% RH (non-condensing)
IP Class	IP 50
Battery Life	10+ hours continuous
Range	70-90 ft. (Class 1) or 30-40 ft. (Class 2) in most cases (varies depending on the Bluetooth capability of smart device used). Under perfect conditions (clear line of sight and low interference) communications can extend up to 300 feet.
Bluetooth Radio	Class 1 Bluetooth 2.1 Radio
Size	6" long x 1.6" wide x 2.3" thick (15.3 x 4 x 5.8 cm)
Weight	0.5 lbs (225 grams)
Superheat and Subcool	Automatically calculated by the ManTooth App
Max. and Min. Pressures	Displays and records the max and min pressures
Refrigerant Database	126 NIST refrigerant profiles included; upgradeable
Screenshot Feature	Save pressure and temperature readings from your sessions which can be automatically organized by location and serviced unit
Temperature Sensors	Capable of measuring 2 temperatures using high accuracy NTC thermistors
Pressure Transducers	67001/67003 – one 67002 – two
System Attachment	Very small internal volume minimizes refrigerant loss during system analysis.
Pressure Zeroing	Simple single button zeroing at the start of each session
Elevation Compensation	Enter at start of session for effortless psia compensation
Battery	Rechargeable LiPo battery



- iPhone and iPad are registered trademarks of Apple Inc., registered in the U.S. and other countries.

- Android is a trademark of Google Inc.  
- The Bluetooth® word mark and logos are registered trademarks owned by Bluetooth SIG, Inc. and any use of such marks by Ritchie Engineering is under license. Other trademarks and trade names are those of their respective owners.



## OMNI™ DIGITAL VACUUM GAUGE



The YELLOW JACKET® OMNI™ Digital Vacuum Gauge is an easy-to-use, compact vacuum gauge that is loaded with features for the price. And it's rugged, too. Made with high impact, glass reinforced housing, it survives moisture and accidental drops or attachment to a high pressure line. The easy-to-clean vacuum sensor handles 450 psi positive pressure and reads several units of vacuum (microns, millibar, Torr and Pascal).

- Audio and visual signal when target vacuum level is reached
- Electronic paper display for clear visibility – even in direct sunlight
- Rich and intuitive user interface – turn it on and it is ready to use with default settings
- 45° degree bend for fitting (1/4" or 5/16")
- Automatic power down and time out
- Power savings - multiple time-out selections
- Low battery indicator and automatic power-down when inactive
- Adapter fittings available
- Made in the USA 

*Compact, easy-to-use, and more unique features than any other unit on the market.*

### Specifications

Vacuum Reading Resolution:	1 micron (from 1,000 to 5 microns) 10 microns (from 10,000 to 1,000 microns) 100 microns (from 25,000 to 10,000 microns)
Display Vacuum Measurement Accuracy:	+/- 20% of reading (from 10,000 to 25 microns)
Vacuum Reading Range:	5 to 25,000 Microns (33.3 mBar, 25 Torr, 3330 Pa); Progress bar-graph from Atmosphere (ATM) to 25,000 Microns
Proof Pressure:	450 psi
Working Temperature:	32°F to 104°F (0°C to 40°C)
Storage Temperature:	-4°F to 140°F (-20°C to 60°C)
Working Humidity:	0-95% RH (non-condensing)
Class:	IP-50
Battery Life:	100+ hours continuous
Battery:	(2) AAA batteries (included)
Size:	6" long x 1.6" wide x 1.6" thick including fitting (15.3 x 4 x 4 cm)
Weight:	0.39 lb (175 grams)
Warranty:	One year

UPC#	Description
69020	OMNI™ Digital Vacuum Gauge with 1/4" Coupler
69021	OMNI™ Digital Vacuum Gauge with 5/16" Coupler



## VACUUM SENSOR CLEANING KIT

Follow cleaning procedure for these YELLOW JACKET® vacuum gauges: 69020 series OMNI™, 67030 series used with P51 digital manifold and Mantooth gauges or 69086 digital vacuum gauge.

Made in the USA 

UPC#	Description
69030	Vacuum Sensor Cleaning Kit



## DIGITAL VACUUM GAUGE

### Seven units of vacuum for confidence

This easy-to-use gauge shows that air and moisture have been removed from the system. A simple push of a button changes the display readout between 7 units of measurement. **Each displays from atmosphere to 10 microns (bargraph indication above 25000 microns) of vacuum to let you know that your vacuum pump is clean and performing properly.** If the sensor gets dirty, simply plug a new sensor into the gauge, run through a quick calibration process and be back on the job within minutes.



This product is protected by one or more of U.S. Patent Number: 6,779,350; 6,832,491; 7,073,346; 7,310,965; and 7,428,822.

- Unique patented thermal conductivity sensor automatically compensates for temperature
- Replaceable, cleanable, plug-in sensor (Part #69087) handles 450 psi positive pressure
- Displays seven different units of vacuum (microns, milliTorr, Torr, millimeters of mercury, millibar, kiloPascal and Pascal)
- 12" coiled sensor cord stretches to 24" for easy reach, connectivity and readability of display
- Low battery indicator
- Automatic shut-off after 20 minutes
- Calibration standards traceable to NIST
- 32° to 122°F (0° to 50°C) operating temperature range
- 14 oz. (392 g) with battery
- Approximately 25 hours continuous battery life
- Accuracy  $\pm 20\%$  of reading
- Made in the USA 

UPC#	Description
69086	Hand-held vacuum gauge with fabric carry pouch
69087	Replacement sensor for older models without detachable cords
69088	Replacement cable for original version - not detachable
40819	Replacement cable for new version - detachable
69101	Replacement sensor and cord assembly
69091	Replacement fabric pouch
69030	Vacuum Sensor Cleaning Kit



## SUPEREVAC™ LCD VACUUM GAUGE

### Full range from atmosphere to 1 micron

The SUPEREVAC™ LCD vacuum gauge combines thermocouple sensor technology with advanced electronics for precise readings and repeatability not found with thermistor sensors or analog meters.

Thermocouple technology has long been proven in laboratory and precision industrial instrumentation for sensing the deep vacuum range. Thermocouple sensors are factory calibrated and exhibit few of the electronic variances of thermistor sensors found in many other electronic gauges. Durable molded case with storage for sensor, cable and brass connector.

Specifications	
Response time:	3 seconds
Calibration:	Automatic
Warm up:	3 seconds
Sensor cable:	5.5' (167 cm) coiled
Sensor connection:	1/4" Male flare
Maximum pressure:	To avoid sensor damage, do not exceed 5 psig
Operating temperature range:	32° to 120°F (0° to 49°C)
Display:	0.5" LCD with battery check
Automatic shut-off:	Yes
Power:	D cell battery, 70 hours continuous battery life
Dimensions:	9" x 12.25" x 2.37" (230 mm x 310 mm x 60 mm)
Accuracy:	± 20% of reading
UPC#	Description
69075	SUPEREVAC™ LCD vacuum gauge full range complete in case
69067	Optional ball valve to add to sensor 1/8" NPT Female x 1/4" Female flare
69071	Brass connector 1/4" Female flare x 1/4" Female flare
69073	Replacement sensor for 69070, 69075
19110	Optional coupler to add to sensor 1/8" NPT Female x 1/4" Female flare
69058	Replacement cord



#### Thermocouple sensor features:

- No adjustments or warm-up. Stays calibrated after on/off switching and long evacuations
- Automatic battery compensation
- Automatic ambient temperature compensation
- Replacement sensor requires no calibration

#### LCD gauge features:

- Automatic off 20 minutes after power up and no change
- Normal handling and jarring will not affect the LCD reading
- Case protects electronic circuitry and sensor
- Calibration standards traceable to NIST
- Precision circuitry controls sensor and translates sensor input into micron readings
- Made in the USA

## DIGITAL LCD ECONOMY VACUUM GAUGE



This product is protected by one or more of U.S. Patent Number: 6,779,350; 6,832,491; 7,073,346; 7,310,965; and 7,428,822.

The digital LCD economy vacuum gauge indicates air and moisture have been removed from the system. Track down the 14 level bargraph from atmosphere to 25 microns to know that the system is clean and the vacuum pump is performing properly. Packaged complete with 9V alkaline battery and hanging hook.

- Unique thermal conductivity sensor automatically compensates for temperature with no calibration
- Simple On/Off controls
- Easy-to-clean sensor handles 450 psi positive pressure
- Rugged contractor-grade construction with tough ABS housing and solid state circuitry for accuracy
- Automatic battery saver shuts gauge off after 20 minutes with no reading changes
- Low battery indicator
- Calibration standards traceable to NIST
- Patented technology
- Made in the USA

To keep the 69080 vacuum gauge accurate, it is best to avoid oil contamination. Keep the sensor vertical whenever possible and connect the gauge directly to the system, away from the pump.

UPC#	Description
69080	Digital LCD vacuum gauge with battery, hook and pouch
69081	Replacement soft-sided protective case
69079	Replacement battery door and screw
69095	Tee fitting

## REFRIGERANT ANALYZER

Speed, accuracy and portability



*Built-in printer (68947) runs an instant receipt for convenient and accurate customer billing.*

- Dispersive infrared technology quickly determines the weight concentrations of R-12, R-134a, hydrocarbons and air
- Analytical software identifies EPA SNAP approved blends, as well as illegal replacements and blends including propane and butane
- Quickly and automatically determines purity of R-12 and R-134a to help eliminate potential of human error
- Large, easy-to-read graphing display
- Rechargeable battery lasts all day
- Rugged portable case includes R-12 hose with 1/4" flare and R-134a with auto coupler

### Specifications

Operating temperature range: 40° to 130°F  
 Operating humidity: 0-95% RH non-condensing  
 Display: 128 x 64 pixel LCD  
 Resolution: 0.1%  
 Output: Digital display and LEDs, optional printer module (internal)  
 Power: 12V, via battery clips (optional power supply available)  
 Weight: 8.0 lbs.  
 Start to finish: 60 seconds

UPC#	Description
68940	HVAC Multi refrigerant analyzer
68941	R-134a Refrigerant analyzer; R-40 sensitive
68945	Refrigerant analyzer (R-12, R-134a, HC, and EPA SNAP approved blends)
68947	Refrigerant analyzer with printer
68948	Optional internal rechargeable battery kit with battery and 110V charger
68949	Optional 110/220V power adapter
68950	Thermal printer paper - 1 roll
68977	In line identifier replacement filter
68978	R-12 replacement hose
68979	R-134a replacement hose

## POCKET THERMOMETERS

1" and 1-3/8" dial thermometers are adjustable with a 5" stainless steel stem. Colored sheath with pocket clip.

- Individually calibrated
- Shock resistant



UPC#	Description
69251	1" Dial 0° to 220°F (12 pak)
69252	1" Dial 40° to 160°F (12 pak)
69253	1" Dial 50° to 550°F (12 pak)
69255	1-3/8" Dial -40° to 160°F (-40° to 70°C) (12 pak)
69256	1-3/8" Dial 0° to 220°F (-10° to 110°C) (12 pak)
69265	1" Dial 0° to 70°C (12 pak)

## POCKET DIGITAL THERMOMETER

Digital head rotates 180° for easy reading.

- On/off button
- Auto off after 10 minutes
- Reading updates every second
- 5" (125 mm) stem



UPC#	Description
69107	Digital thermometer -58° to 302°F (-50° to 150°C)
69250	69107 display (12 pak)
69110	Battery

## PISTOL-GRIP INFRARED THERMOMETER

With wide measurement of -40° to 932°F, this easy-to-use tool is the effective choice for high or low temperature and refrigeration applications. For accuracy and resolution, the focal point is a tight 10:1 ratio with laser sighting.

- Selectable 3-point emissivity for simple set-up
- Backlight for dark area use
- °F/°C switchable
- ± 2% or 2°C accuracy
- 0.1°F resolution at -40° to 212°F (-40° to 100°C)
- Fast response time of 500 msec



D = Distance to object  
 S = Spot diameter

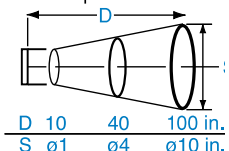

UPC#	Description
69228	Pistol-grip infrared thermometer

## DIGITAL THERMOMETER PROBES

### Differential and single

#### Single Probe "K" type:

- Single "K" type input
- °F/°C switchable
- Maximum and minimum hold
- Low battery indicator
- Power off after 30 minutes

#### Differential "K" type:

- Dual "K" type thermocouple inputs
- T1, T2 or T1-T2 differential readings
- Resolution 1°

#### Specifications

Temperature range: -58° to 1999°F (-50° to 1300°C)  
 Resolution: 0.1 or 1°  
 Display: LCD 5/8" (16 mm)  
 Operating temperature range: 32° to 120°F (0 to 49°C)  
 Storage temperature range: -20° to 130°F (-29 to 54°C)  
 Power: 9V, battery life approximately 200 hours  
 Dimensions: 7.2" x 2.75" x 1.6" (180 mm x 70 mm x 40 mm)  
 Accuracy: -58° to 1800°F ± (0.3% of reading + 2°F); -50° to 982°C ± (0.3% of reading + 1°C)



UPC#	Description	Maximum temperature	Length	Response time (sec.)
69215	Type "K" air probe (A)	1112°F (600°C)	4 ft. (1.21 m)	5
69217	Type "K" 1.375" clamp-on probe (D)	248°F (120°C)	10 ft. (3.05 m)	3
69218	Type "K" general purpose probe (E)	500°F (260°C)	3 ft. (0.91 m)	3
69220	Type "K" surface probe (C)	1650°F (900°C)	4 ft. (1.21 m)	3
69222	Type "K" puncture probe (B)	1112°F (600°C)	4 ft. (1.21 m)	12

## ANEMOMETER



This hand-held instrument reads both air velocity and temperature simultaneously when balancing air conditioning/heating ventilation systems.

- Microprocessor controller
- Calculates cfm air volume
- Records minimum and maximum readings
- Averages air velocity
- Display "hold" button freezes LCD reading
- °F/°C switchable
- Auto off after 20 minutes
- RS232 output

#### Specifications

Air flow ranges: 125 – 4900 ft/min  
 Resolution: 1 ft/min and 0.01 m/sec.  
 Accuracy: ±2%  
 Temperature: 14° to 122°F (-10° to 50°C)  
 Resolution: 0.01°F and 0.1°C  
 Accuracy: ±1.0°F (±0.6°C)  
 Power: 9V battery, battery life approximately 100 hours  
 Fan diameter: 2-7/8" (70 mm)

UPC#	Description
68915	Anemometer kit
68916	Replacement 2.75" (70 mm) diameter probe assembly

## DIGI-ALARM THERMOMETER



Extended reach stainless steel probe.

This compact unit measures from -58° to 392°F (-50° to 200°C) and triggers an alarm at the high and low programmed temperatures.

- No calibration
- °F/°C switchable
- Data hold function
- Key tone for operation confirmation
- Maximum/minimum temperature memory
- Foldaway stand
- Automatic self test after battery installation

#### Specifications

Measurement range: -50 to 200°C / -58 to 392°F  
 Accuracy: ±1°C between -19.9 to 119.9°C  
 ±2°C between 120 to 199.9°C  
 otherwise ±3°C  
 ±1.8°F between -3.8 to 183.8°F  
 ±3.6°F between 248 to 391.8°F  
 otherwise ±5.4°F  
 Display resolution: 0.1° over full range  
 Alarm resolution: 1° over full range  
 Sampling rate: 1 second  
 Battery: Requires one 1.5 volt size AAA/UM4 or equivalent (included)  
 Ambient temperature: 0 to 50°C / 32 to 122°F

UPC#	Description
69239	Digi-alarm thermometer



# LEAK DETECTORS AND LEAK MONITORS





## AccuPROBE™ Leak Detectors

The only tool you will need for fast, easy and certain leak detection.





## AccuProbe™ IR LEAK DETECTOR

Use the infrared (IR) sensor for ultimate sensitivity, accuracy and reliability. Identifying the smallest leaks is fast and easy. Detects all CFC, HCFC, HFC and HFO refrigerants, including R-134A, R-404A, R-410A and R-1234YF. The Smart Alarm LED shows the size of the leak on a rising scale. Coupled with two modes for sensitivity gives the AccuProbe™ IR the ability to locate a leak of any size.

- Sensor Type: Infrared
- Senses All CFC, HCFC, HFC and HFO Refrigerants
- Sensitivity Modes: High and Low (Auto Zero)
- Manual zero capability
- Audible and Visual Leak Indication
- Regulations: CE, EN14624, EN61010, SAE2913
- Rechargeable Li-Ion Battery
- Sensitivity will not degrade over time
- USB micro charging port (cable included)
- Includes one (1) spare filter
- Includes carrying case
- Two year over-the-counter warranty
- Made in the USA 

### Specifications

- Minimum Sensitivity: 0.1 oz/ yr. (3 g/yr.)
- Body Material: ABS
- Body Length: 8.25" (210 mm)
- Probe Length: 17" (430 mm)
- Weight: 0.84 lb. (0.38 kg)
- Calibration: Automatic
- Response Time: Instantaneous
- Battery Life: 8 hours
- Fast Charge Time: 3 hours
- Holds Charge When Not In Use: 9 months (app.)
- Operating Temperature Range: -4°F to 140°F (-20°C to 60°C)

### UPC# | Description

69320	AccuProbe IR™ Leak Detector
-------	-----------------------------

### Accessories and Parts

69321	Replacement Filters (5 pack)
-------	------------------------------

**NEW**



Use the solid electrolyte sensor or UV technology (or both at the same time) to detect the more current and difficult HFC refrigerants such as R-134a, R-404A, R-407 and R-410A, in addition to all HCFC (R-22) refrigerants including SNAP approved hydrocarbon and HFO refrigerants, all with minimal chance of false alarms.

## AccuPROBE™ UV LEAK DETECTOR

Our solid electrolyte sensor technology reduces heat and gives the sensor longer life than traditional heated anode or heated diode detectors.

3 UV lights fluoresce between 395 and 415 nanometers.

The Smart Alarm™ LED shows how big or small a leak is on a scale of one to nine:

- 1 to 3 – less than 0.1 oz./yr.
- 4 to 6 – 0.1 to 0.5 oz./yr.
- 7 to 9 – more than 0.5 oz./yr.

In addition to the Smart Alarm indicator, the AccuPROBE UV features low, normal and high sensitivity levels with visual and audible signals.

- If there is no response from the flashing tip or beeping signal at the preset normal sensitivity in the general area of a suspected leak, select high sensitivity
- High sensitivity will detect even low levels that could be missed with other detection systems
- Use low sensitivity as you move the tip over more defined areas of a system



*The frequency of flashing from the electrolyte sensor tip increases as you get closer to a leak and refrigerant concentration increases. The*

*audible alert, which can also be muted, increases in frequency and duration as concentration increases.*

- Robust, ergonomic design is easy to use in close areas and extendable into hard-to-reach areas
- Long life, stable sensor
- Instantaneous response time
- Clears in 12 seconds or less after exposure to a 1.75 oz (50g)/yr. leak
- Automatic calibration and reset to ambient
- Low battery indicator
- Microcontroller technology
- SAE J2913 certified, CE marked, EN 14624
- 24-month limited warranty
- Made in the USA

### Specifications

<b>Sensitivity:</b> HFC (R-134a) 0.06 oz. (1.7g)/yr. HCFC (R-22) 0.03 oz. (0.9 g)/yr. HFO (1234yf) 0.15 oz. (4.3 g)/yr.	<b>Calibration:</b> Automatic
<b>Heated solid electrolyte sensor:</b> Over 300 hours service life with minimal cleaning and no adjustments	<b>Response time:</b> Instantaneous
<b>Maintenance required:</b> None	<b>Power:</b> 4 AA alkaline batteries, 4.5 hours continuous life
<b>Body length:</b> 10.5" (270 mm)	<b>Operating temperature range:</b> 24° to 125°F (-4° to 52°C)
<b>Probe length:</b> 17" (430 mm)	<b>Storage temperature range:</b> -4° to 122°F (-20° to 50°C)
<b>Weight:</b> 17 oz. (480 g)	<b>Humidity:</b> 0 to 95% RH non-condensing
<b>Warm up time:</b> 20 seconds or less	<b>Approvals:</b> SAE J2913 CE marked, EN 14624

UPC#	Description
69336	AccuPROBE UV
69337	AccuPROBE UV with global power supply (US, EU, UK, AU, NZ)
69338	AccuPROBE UV - Japan

### Accessories and Parts

69375	A/C Adapter - global power supply (US, EU, UK, AU, NZ) CE and GS approved
69383	Kit – sensor, filters and bottle
69384	Replacement sensor and filter
69385	Sensor filters (5 pak)
69386	Leak sensor bottle
69387	Carrying case with inserts
69388	Battery cover/screw (AccuProbe UV)

## AccuPROBE™ II LEAK DETECTOR



Low, normal and high sensitivity levels with audible signals to quickly and easily pinpoint leaks.



### Specifications

<b>Sensitivity:</b> HFC (R-134a) 0.06 oz. (1.7 g)/yr. HCFC (R-22) 0.03 oz. (0.9 g)/yr. HFO (1234yf) 0.15 oz. (4.3 g)/yr.	<b>Probe length:</b> 17" <b>Weight:</b> 15 oz.
<b>Sensor life:</b> Over 300 hours service life with minimal cleaning and no adjustments	<b>Warm up time:</b> 20 seconds or less
	<b>Power:</b> 4 AA alkaline batteries, 4.5 hours continuous life
	<b>Approvals:</b> SAE J2913 CE marked, EN 14624

UPC#	Description
69354	AccuPROBE II leak detector
69383	Kit – sensor, filter and bottle
69384	Replacement sensor and filter
69385	Sensor filters (5 pak)
69386	Leak sensor bottle
69387	Carrying case with inserts
69361	Zipper pouch

## Tips for Detecting System Leaks with Leak Detector:

1. Inspect entire A/C system for signs of oil leakage, corrosion cracks or other damage. Follow the system in a continuous path so no potential leaks are missed.
2. Make sure there is enough refrigerant in the system (about 15% of system capacity or 50 psi min.) to generate pressure to detect leaks.
3. Check all service access port fittings. Check seals in caps.
4. Move detector probe at 1" per second within 1/4" of suspected leak area.
5. Refrigerant is heavier than air so position probe below test point.
6. Minimize air movement in area to make it easier to pinpoint the leak.
7. Verify an apparent leak by blowing air into suspected leak to clean the area and see if the leak remains.
8. When checking for evaporator leaks, check for gas in condensate drain tube.

## ELECTROLYTE SENSOR

### Electrolyte Sensor Leak Detectors

When the electrolyte sensing element is exposed to refrigerant, an electrochemical reaction changes the electrical resistance within the element, causing an alarm. The sensor is refrigerant specific with superior sensitivity to all HFCs and HCFCs, and minimal chance of false alarms. When exposed to large amounts of refrigerant, which could poison other systems, the electrolyte sensor clears quickly and does not need recalibration before reuse.

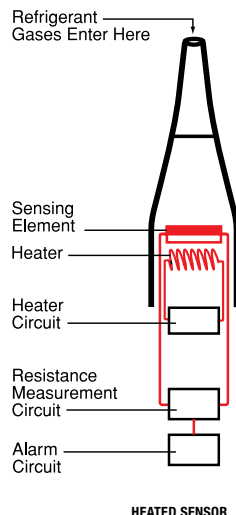

## H<sub>2</sub> DETECTOR

### Detects 5% H<sub>2</sub> in 95% Nitrogen Tracer Gas



Many countries are now adopting laws that ban the use of refrigerants for system testing. The YELLOW JACKET H<sub>2</sub> was developed for the H<sub>2</sub> (95% nitrogen and 5% hydrogen) tracer gas mixture.

When used with the H<sub>2</sub>/nitrogen tracer gas mixture, the YELLOW JACKET H<sub>2</sub> will detect leak rates less than 5 ppm.

- Long life, stable sensor
- Does not require rechargeable batteries
- Automatic calibration and reset to ambient
- Three adjustable sensitivity levels
- Low battery indicator
- CE Certified
- True mechanical pump
- Two-year warranty
- Made in the USA 

### Specifications

Sensitivity: Less than 5 ppm	Warm up time: 20 seconds or less
Sensor life: Over 300 hours	Power: 4 AA alkaline batteries, 8 hours continuous life
Response Time: Instantaneous	Approvals: EN35422 and EN14624
Probe length: 17" Weight: 1.5 lbs.	

UPC#	Description
69341	H2 leak detector
69342	Replacement sensor
69343	Carrying case with inserts (grey)

## MICRO LED UV LEAK DETECTION KITS AND LAMPS For all A/C systems and lamps



Individual reflectors surround each of five LEDs recessed for protection in the stainless steel head.

- Long life LEDs
- Constant ON switch
- Sealing locks out moisture
- AA Alkaline battery included (dispose of batteries via disposal practices in your area)
- Aluminum body

UPC#	Description
69782	395-415 nm wavelength UV LED flashlight
69788*	Micro UV LED and dye kit for auto
69789*	Micro UV LED and dye kit for AC/R
69793	Replacement pouch for LED (for older style with black casing)
69794	Lithium battery (2 pak) (for older style with black casing)

\* Not for direct injection into R-410A systems due to high pressure. Bulbs not replaceable.

## LARGE SYSTEM INJECTORS

Systems with up to 32 gallons of lubricant



Self-contained injection system for inducing up to 16 oz. of universal AC/R dye into the largest systems. Add to the lo-side. Easily works on all system pressures to 300 psi, .35 oz. per stroke. Hose included with SealRight end.

- Recommended for R-410A
- Made in the USA 

UPC#	Description
69555	Large system injector
77950	Large system injector with coupler

## CALIBRATED A/C SCREW INJECTION



This 2 oz. injector is easy to refill and easy to operate. Calibrations are clearly marked on the injector. Connect to A/C lo-side and rotate handle. AC/R and auto models. Maximum port pressure of 250 psi.



UPC#	Description
69729	Universal screw injector (no hose)
69730	1/4" Calibrated A/C screw injector (with hose)
69731	Auto R-134a calibrated A/C screw injector with service coupler
69732	Auto R-134a calibrated A/C screw injector without service coupler
69723	1/4" replacement hose
69724	R-134a replacement hose

## UNIVERSAL A/C DYE INJECTORS AND HOSE



Universal A/C dye injectors work in AC/R and auto A/C systems. Four 1/4 oz. applications of dye in each disposable tube make it economical, fast and clean. Hose features back flow check valve.

- Maximum system port pressure of 80 psi
- Not for direct injection into R-410A systems due to high pressure
- Made in the USA 

UPC#	Description
69702	Hose plus 2 injectors for AC/R
69703	Auto R-134a hose, coupling and injectors
69705	Injector hose with SealRight
69706	Auto R-134a injector hose and service coupler

US Patent # 6,164,348

## DYE AND OIL INJECTORS



Body and cap are rugged aluminum with an "O" ring seal. 1/4" Male fitting at one end with Schrader. A ball valve for control on other end with a short length of hose. Valve depressor in 1/4" Female end. 600 psi working pressure.

Saves time on many applications:

- Add oil to system
- Put oil in after changeout
- Add scanner fluorescent solution
- Add additives to system
- Refrigerant sampling
- Recommended for R-410A
- Made in the USA 

UPC#	Description
69559	1/4 oz. Oil injector
69560	1/2 oz. Oil injector
69561	2 oz. Oil injector
69562	4 oz. Oil injector
69563	"O" ring 1/4 and 1/2 oz. injector (5 pak)
69564	"O" ring 2 and 4 oz. injector (5 pak)
69722	Replacement hose

## UNIVERSAL A/C DISPOSABLE INJECTORS

Universal disposable 1 oz. applicator for fast economical dispensing. Universal dye for all common refrigerants and oils. Two 1/2 oz. applications for regular split systems or four 1/4 oz. applications for small appliances or auto A/C.



US Patent # 6,164,348

- Less costly and faster than many other methods
- One dye minimizes inventory
- No back-up refrigerant to move dye into system
- Maximum system port pressure of 80 psi
- Not for direct injection into R-410A systems due to high pressure
- Made in the USA 



Easy to use: connect to system, push in plunger, then disconnect

UPC#	Description
69700	1 oz. (30 ml) Injector (6 pak) (12 residential applications/case)
69721	1 oz. (30 ml) Injector (2 pak) (4 residential applications/package)
69727	1 oz. (30 ml) Injector

CHARGING SYSTEMS  
GAUGES  
RECOVERY MACHINES  
VACUUM PUMP SYSTEMS  
VACUUM AND CHARGING HOSES  
HOSE ADAPTERS, VALVES & PARTS  
WIRELESS AND ELECTRONIC INSTRUMENTS  
LEAK DETECTORS AND MONITORS  
HEATING INSTRUMENTS  
SYSTEM TOOLS



## UNIVERSAL A/C DYE SOLUTIONS



Universal dye for A/C systems with mineral, alkyl benzene or polyol ester lubricants.

- Field proven and sold worldwide
- Passed thermal stability tests
- One dye for AC/R systems
- Raw material QC assures dye uniformity
- Made in the USA 

UPC#	Description
69711	1/4 oz. (7.5 ml) Universal A/C (24 pak)
69708	1/2 oz. (15 ml) Universal A/C (12 pak)
69709	1 oz. (30 ml) Universal A/C (6 pak)
69710	2 oz. (60 ml) Universal A/C (6 pak)
69712	8 oz. (240 ml) Universal A/C
69713	8 oz. (240 ml) Universal A/C (6 pak)
69803	1 gal. (3.78 L) Universal A/C

Oil/fluid and coolant dyes available on page 87.

### DYE APPLICATION AMOUNTS

#### Application

Small appliance  
A/C or refrigerant systems  
Larger systems

#### System size in lbs. of refrigerant

Up to 4.9 lbs. (2.22 kg)  
Up to 25 lbs. (11.34 kg)  
Above 25 lbs. (11.34 kg)

#### Universal dye amount

0.25 oz. (7.5 ml)  
0.5 oz. (15 ml)  
0.5 oz. (15 ml) per gallon of oil

Not recommended for systems with internal temperatures below -40°F.  
Compatible with mineral, alkylbenzene, ester and PAG oil systems.

## FLUORESCENT SCANNER SOLUTIONS

Technology to match refrigerant and system volume



69621

Different concentrations of fluorescent solutions are available to match the refrigerant volume in a system.

- Operating temperature is -40°F for all solutions
- When working on split systems, use solution 3 even if system has 10 lbs. or less of gas
- Made in the USA 

01 – Systems with up to 2.9 lbs. gas

1 – Systems with 1 to 4.9 lbs. gas

2 – Systems with 5 to 9.9 lbs. gas

3 – Systems with 10 to 25 lbs. gas

#### Self-infusing Injector Tubes

Solution Concern	System Size	Ester Oil System
01 (0.03 oz.)	up to 2.9 lbs.	69620
1 (0.5 oz.)	up to 4.9 lbs.	69621
2 (0.5 oz.)	up to 9.9 lbs.	69622
3 (0.5 oz.)*	up to 25 lbs.	69623



## FLUORESCENT SOLUTIONS

### For non-refrigerant applications



The oil and fluid dye solution is for finding leaks in oil-based applications. Use 1 oz. per 2 gallons of oil.

- Pin point leaks in milling machines and hydraulic systems such as cherry pickers

- Find seal and gasket leaks in engines, compressors and transmissions
- Locate leaks in gasoline or diesel fuel equipment, offset printing presses, injection-molding machines, locomotive engine oil coolers and oil-cooled chillers
- Made in the USA 

UPC#	Description
69733	1 oz. (30 ml) Oil and fluid dye (6 pak)
69734	1 oz. (30 ml) Oil and fluid dye (24 pak)
69735	8 oz. (240 ml) Oil and fluid dye

**YELLOW JACKET solutions meet or exceed applicable ASHRAE and ANSI tests and SAE standard J2297 for R-134a UV leak detection.**

## COMBUSTIBLE GAS DETECTOR

### With ultra-sensitive, long life sensor



Detects all hydrocarbon and other combustible gases including propane, methane, butane, industrial solvents and more.

Unit is preset at normal sensitivity, but you can switch to high or low. Slow beeping indicates that unit is warmed up. Frequency increases when a leak is detected until an alarm sounds when moving into high gas concentration. The Smart Alarm™ LED indicates leak size.

If no leak is detected in a suspected area, select high sensitivity. This will detect even low levels in the area. Move the tip over more defined areas, and you will be alerted when the tip encounters the concentration at the leak source.

- Ultra-sensitive sensor detects less than 15 ppm methane and better than 12 ppm for propane. Performs equally well on a complete list of detectable gases including acetylene, butane and isobutane
- Automatic calibration and zeroing
- Sensor replaceable after full service life
- Smart Alarm LED shows how big or small a leak is on a scale of one to 9.
- 24-month limited warranty (12-month warranty on sensor)
- Made in USA 

## CLEANERS



**Scan-off UV Cleaner**  
Water-based biodegradable spray cleans scanner solution from system.

**Natural Degreaser**  
Heavy duty biodegradable degreaser removes scanner solution from system.

**Hand Cleaner**  
Cleans solution from hands.

UPC#	Description
69698	19 oz. Natural degreaser #01020
69699	16 oz. Hand cleaner
69696	8 oz. Scan-off solution
69697	8 oz. Scan-off solution (12 pak)

### APPLICATIONS:

- Internal gas lines/pipes
- Propane filling stations
- Gas heaters
- Combustion appliances
- Hydrocarbon refrigerant
- Heat exchangers
- Marine bilges
- Manholes
- Air quality
- Arson residue (accelerants)

### Specifications

Warm up time: 25 seconds  
 Power battery: 4 AA alkaline batteries, 20 hours continuous life  
 Probe length: 17" (43.17 cm)  
 Sensor life: 500 hours  
 Body length: 10.5" (26.67 cm)  
 Weight: 16 oz. (0.45kg)  
 Operating temperature range: 32° to 110°F (0° to 43°C)

UPC#	Description
69371	Replacement sensor
69372	Replacement sensor cover
69373	Combustible gas detector with case
69387	Carrying case – blow molded
69379	Battery cover and screw (2003-2011)

CHARGING SYSTEMS  
 GAUGES  
 RECOVERY MACHINES  
 VACUUM PUMP SYSTEMS  
 VACUUM AND CHARGING HOSES  
 HOSE ADAPTERS, VALVES & PARTS  
 WIRELESS AND ELECTRONIC INSTRUMENTS  
 LEAK DETECTORS AND MONITORS  
 HEATING INSTRUMENTS  
 SYSTEM TOOLS

## SUPERHEAT CALCULATION KIT



Easily take an internal temperature reading for calculating system superheat.

- Read from -58° to 302°F (-50° to 150°C)
- °F/°C switchable
- Extract Schrader cores without opening system
- Remove broken Schrader cores
- Chase damaged threads
- Replace cores
- Use as vacuum valve to increase flow and reduce vacuum and charging time
- Use to reduce recovery time
- Made in the USA 



69104

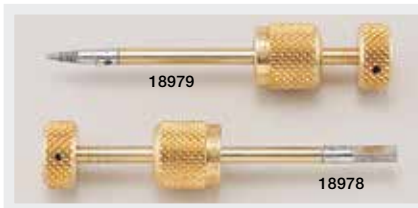

18979

18978

Accessory set 18980.

UPC#	Description
69103	Superheat kit without accessory kit
69104	Complete superheat kit and accessories (as shown)
69106	Digital thermometer and nut - 40° to 230°F
69107	Pocket thermometer (made in China)
18975	Improved vacuum/charge valve
18978	Schrader rethreading accessory
18979	Broken Schrader remover accessory
18980	Accessory set - 2 piece
18997	Grappler rod and nut assembly

## SLING PSYCHROMETER

Measures wet and dry bulb temperatures of surrounding air for immediate conversion of readings to relative humidity percentage.

- One piece unit in self-contained housing fits into your pocket
- Calibrated and easy-to-read
- “Slide rule” scale built into case
- Accurate to 1 percent of “Hygrometric Tables”



Does not contain mercury.

UPC#	Description
69010	Sling psychrometer
69011	Replacement wicks (5 pak)
69015	Replacement thermometer

## WATER-TYPE MANOMETER

Economical plastic tube manometer helps you set manifold pressure for natural or L.P. gas. Goes to -2" W.C. for newer systems.

- Strong magnet on manometer holds it in convenient upright position
- Includes tubing with fitting
- Made in the USA 

UPC#	Description
78070	-2" - 0 - 7-1/2" scale manometer
78075	-2" - 0 - 15" scale manometer
78071	Tubing with fitting
59511	Brass fitting only



## DIGITAL ELECTRONIC MANOMETER



The digital electronic manometer eliminates the mess and fragility of U-tubes or diaphragm type gas pressure gauges. This easy-to-use instrument provides a continuous display of the measured positive or negative pressure. Ideal for setting gas pressure at manifold, checking pressure, flue draft and air balancing. Kit includes battery, 18" tubing and brass fitting.

- Display unit: inches of water
- -19.95" to 19.95" water gauge
- Accuracy: ±1.5% FS (±0.3 inches of water)
- 0.05" water column resolution
- Large LCD display
- Automatic off
- Long battery life
- Made in the USA 

UPC#	Description
78052	Dual port digital electronic manometer
69089	Battery door
78071	18" Tubing with fitting
59511	Brass fitting only



## DIGITAL PSYCHROMETER



Quickly measure humidity, dry bulb, dew point and wet bulb. No need to whirl a meter or refer to a chart for results.

- °F/°C switchable
- Data hold
- Auto power off
- Display relative humidity and temperature simultaneously
- Response time of 60 seconds to changes in humidity

### Specifications

Temperature range: -4° to 122°F (-20° to 50°C)  
 Resolution: 0.1°F/°C, 0.1% RH  
 Operating temperature range: 4° to 122°F (-20° to 50°C) 0-100% RH  
 Power: 2 AAA batteries  
 Dimensions: 7" x 1-7/8" x 1" (178 mm x 48 mm x 25 mm)  
 Weight: 2.65 oz. (75 g)  
 Accuracy: Relative humidity functions (± 3% RH at 25°C)  
 Temperature ± 1°F (0.6°C)  
 Sensors: Temperature: thermistor bead  
 Humidity: polymer film (capacitance)  
 Update rate: 2-6 seconds depending on function

UPC#	Description
69008	Digital psychrometer

## FUEL OIL TEST KIT



Determine pump efficiency, cut-off and suction, as well as analyze or troubleshoot burner efficiency.

Kit includes 2" gauge, 30" 0-150 lb. scale and 12" hose with fittings.



UPC#	Description
78020	Complete fuel oil gauge kit
78021	2" Fuel oil gauge only
78023	Carrying case
78011	12" Hose – no valve opener
78024	Fitting set (4 pak)
78025	Adapter for 1/8" NPT
78031	2-1/2" Gauge, scale 30", 0-150 lbs.
78032	2-1/2" Gauge, scale 30", 0-300 lbs.

All gauges are 1/8" NPT.

## OIL PUMP VIBRATION ELIMINATOR



Reinforced rubber hose helps eliminate noise and vibration when installed in a heating system.

- 1250 psi (86 bar) minimum burst, 250 psi (17 bar) maximum working pressure
- Operating temperature -20° to 180°F (-28.8° to 82.2°C)
- Made in the USA

UPC#	Length	Description
78012	12"	3/8" Male flare x 1/4" NPT Male oil burner connector

## ADAPTER CORD – TEST CONNECTOR

A 12" lead using number 14-3 wire and Female plug one end. Three large clips other end with red, black and green insulators. 120/240V – AC.



UPC#	Maximum amps	Clip size
69522	15 Amp	Large

CHARGING SYSTEMS  
 GAUGES  
 RECOVERY MACHINES  
 VACUUM PUMP SYSTEMS  
 VACUUM AND CHARGING HOSES  
 HOSE ADAPTERS, VALVES & PARTS  
 WIRELESS AND ELECTRONIC INSTRUMENTS  
 LEAK DETECTORS AND MONITORS  
 HEATING INSTRUMENTS  
 SYSTEM TOOLS

## GAS PRESSURE TEST KIT



Easier to use than a manometer, this compact kit helps you accurately set manifold pressure for natural or L.P. gas.

- Sensitive diaphragm gauge calibrated in inches of water column and ounces per square inch
- Improved lamination strength of diaphragm (bellows) to brass plate withstands higher over-pressure
- Tube nipple for easy connection to system manifold
- Two gauge ranges available
- Made in the USA

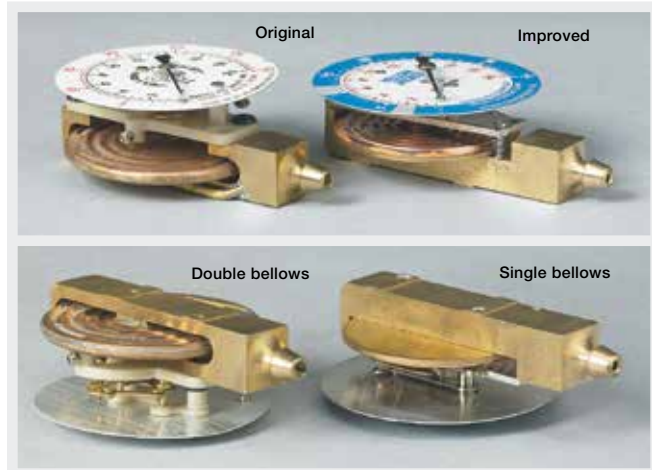

The unique single bellows on brass plate design replaces the double bellows for a stronger seal that better resists over-pressure.

UPC#	Description
78055	Complete test kit – 0-10" W.C.
78056	Barb-fitting gauge – 0-10" W.C.
78057	1/4" NPT Male gauge – 0-10" W.C.
78060	Complete test kit – 0-35" W.C.
78061	Barb-fitting gauge – 0-35" W.C.
78066	1/4" NPT Male gauge – 0-35" W.C.
78062	Hose with nipple
78064	Brass barb-fitting
78065	Rubber nipple
78059	Gauge crystal
78063	Carrying case

## 2" GAS TEST GAUGE

1/2", 3/4" and 1" pipe



Easy-to-read gauge to test system pressure for leaks in new installations. Pressure drop indicates leakage. 0-30 gauge is in 1/4 lb. increments and 0-15 gauge is in 1/5 lb. increments. Brass threaded bell for leak tight connection.

UPC#	Description
78076	2" Test unit 0-15 lb. gauge 1/2" pipe
78077	2" Test unit 0-15 lb. gauge 3/4" pipe
78080	2" Test unit 0-30 lb. gauge 3/4" pipe
78087	2" Test unit 0-60 lb. gauge 3/4" pipe
78090	2" Test unit 0-100 lb. gauge 3/4" pipe
78091	Gauge 1/4" NPT Male 0-100 lb.
78079	2" Test unit 0-15 lb. gauge 1" pipe
78085	2" Test unit 0-30 lb. gauge 1" pipe
78095	2" Test unit 0-100 lb. gauge 1" pipe
78096	Schrader fitting 1/8" NPT Male x tire fitting (0.305" - 32)

## 3-1/2" GAS TEST GAUGE

3/4" and 1" pipe



Larger 3-1/2" gauges are easier to read. Scale in psi and bar. Brass threaded bell for leak tight connection.

UPC#	Description
78084	3-1/2" Test unit 0-30 3/4" pipe
78086	3-1/2" Test unit 0-100 3/4" pipe
78088	3-1/2" Test unit 0-30 1" pipe
78089	3-1/2" Test unit 0-100 1" pipe
49422	Gauge only 3-1/2" test unit 0-60 psi
49421	Gauge only 3-1/2" test unit 0-30 psi
49424	Gauge only 3-1/2" test unit 0-100 psi

# SYSTEM TOOLS



CHARGING  
SYSTEMS

GAUGES

RECOVERY  
MACHINES

VACUUM PUMP  
SYSTEMS

VACUUM AND  
CHARGING HOSES

HOSE ADAPTERS,  
VALVES & PARTS

WIRELESS AND  
ELECTRONIC  
INSTRUMENTS

LEAK DETECTORS  
AND MONITORS

HEATING  
INSTRUMENTS

**SYSTEM TOOLS**





## Deluxe 45° Flaring Tool

A full range 1/8" to 3/4" O.D. flaring tool for soft copper



**YELLOW  
JACKET®**

## DELUXE 45° FLARING TOOL



- Designed with the new R-410A system requirements in mind
- Self-centering yoke grips without marring or constricting tube
- Automatic tube height gauge for correct tubing height
- Multi-faceted burnishing cone produces a burnished flare seat for a positive seal
- Easy-to-use with four basic steps
- Made in the USA

**Note:** To improve grip on copper, all moving parts including the wing nut threads, wing nut mating threads and feed screw threads must be oiled regularly. Failure to do so may result in tubing slippage, undersize flares and damage to the tool.



1. With cone up, open the two dies of the clamping yoke
2. Select sizes on underside of dies to match tubing O.D.



3. Insert tubing until it touches the height gauge
4. Turn the feed screw to flare the tubing

UPC#	Description
60278	Deluxe flaring tool for 1/8" to 3/4" O.D.
60214	Replacement wing nut
60268	Replacement grip
60269	Wing nut and bolt
60273	Burnishing cone and pin
60274	Yoke assembly

### R-410A Flare Diameters

- Installation instructions for systems using R-410A vary between manufacturers with respect to 45° flares. Some require the larger flares produced by the Deluxe 45° Flaring Tool (60278) while others prefer the rolled flare produced by the eccentric cone flaring tool
- Instead of the standard 1/4" (7/16-20 thread, 1/4" O.D.) fitting for air conditioning systems, some manufacturers are moving to 5/16" (1/2-20 thread, 5/16" O.D.) to differentiate fittings and avoid misconnections. These fittings can often be found on mini split systems

### Maximum Diameter of Flare Cone (Average)

Flare size	SAE spec produced by most flaring tools	Some R-410A mfg. specs produced by 60278
1/8"	0.181"	*
3/16"	0.248"	*
1/4"	0.327"	0.358"
5/16"	0.406"	*
3/8"	0.488"	0.520"
1/2"	0.622"	0.654"
5/8"	0.748"	0.776"
3/4"	0.917"	0.945"

\* These tube sizes are not used by some R-410A equipment manufacturers. The Deluxe Flaring Tool 60278 adopts the SAE standard for these sizes.

## ECCENTRIC CONE FLARING TOOL

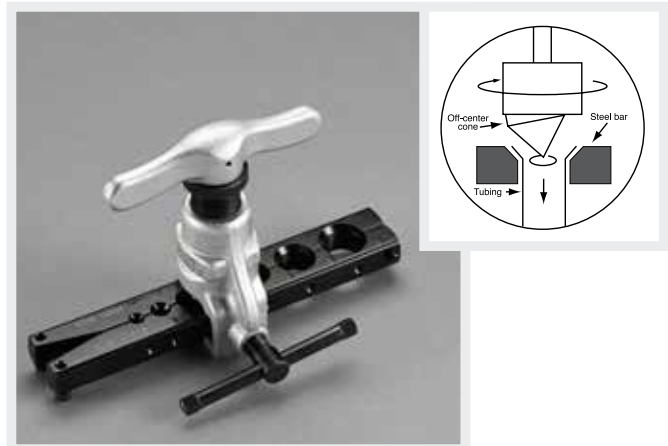

Off-center hardened steel cone with 45° flare produces a rolling action for uniform flare walls without galling in 3/16" to 3/4" O.D. tubing.

- Large feed screw handle for smooth turning with little effort
- Black oxide-finished steel flaring bars are heat-treated for durability and secure grip on tubing
- Recommended for soft materials such as copper and aluminum
- Built-in clutch release to prevent over-torquing

UPC#	Description
60295	Flaring tool with eccentric cone for 3/16" to 3/4" O.D.

## 45° FLARING TOOLS 3/16" to 1-1/8"



60210



60230



60290

- 60210 heavy-duty is designed for tight spaces
- 60230 heavy-duty flares on tubing up to 3/4"
- 60290 large is designed to flare on tubing up to 1-1/8"
- Hardened steel flaring bar to resist tube slippage
- Forged steel yoke that slips over bar and locks with a turn
- Precision threaded feed screw and long handle
- Chrome finish

UPC#	Description
60210	Heavy-duty flaring tool for 3/16", 1/4", 5/16", 3/8", 7/16", 1/2", 5/8" O.D.
60212	Flaring bar only for 60210
60230	Heavy-duty flaring tool for 1/2", 5/8", 3/4" O.D.
60232	Flaring bar only for 60230
60213	Yoke for 60210 up to 5/8" flare
60214	Wing nut
60233	Yoke for 60230 up to 3/4" flare
60290	Large flaring tool for 3/4", 7/8", 1", 1-1/8" O.D.
60293	Flaring yoke for 60290
60292	Flaring bar for 60290

The only replaceable parts are those listed above.

## FLARE/BURNISH TOOL



Multi-faceted cone rolls a precise flare and simultaneously burnishes it on brass, copper and aluminum.

UPC#	Description
60270	Flare/burnish tool for 3/16" to 5/8" O.D.
60271	Flare yoke only for 60270
60272	Flaring bar for 60270

The only replaceable parts are those listed above.

## UNIVERSAL 45° FLARE/BURNISH TOOL



Universal designed bar will hold all inch and metric size tubing up to 5/8" (16 mm).

- Flare bar is compact and easy to use in tight spaces
- Multi-faceted cone rolls out precise 45° flare and burnishes simultaneously
- Flare is formed above flare bar

UPC#	Description
60275	Universal flaring tool for 3/16" to 5/8" O.D.
60276	Flaring bar only for 60275
60277	Flaring yoke only for 60275

The only replaceable parts are those listed above.

## LIGHTWEIGHT SWAGE/FLARE KIT



60430 shown  
60431 includes 6 additional metric pins

The aluminum body and bar makes this half the weight of traditional steel designs.

- Six quick-change positions for flaring soft copper and aluminum tube
- The chrome finish of the swaging pin allows for an easy flare operation
- Strong aluminum bars - each hole flare tested more than 1000 times.
- Swage pin sizes are molded into the case for easy organization
- Quick connect on yoke saves time during pin/cone changing
- Built-in slide gauge to easily meet desired flare sizes without the guesswork.
- One yoke for both flaring and swaging
- Blow-molded carrying case included

UPC#	Kit Swaging/Flaring Sizes
60430	Inches: 6 positions for 1/4, 5/16, 3/8, 1/2, 5/8 and 3/4" O.D. tube
60431	Inches: 6 positions for 1/4, 5/16, 3/8, 1/2, 5/8 and 3/4" O.D. tube Metric: 6 positions for 6, 8, 10, 12, 16 and 18 MM O.D. tube; hex wrench included

UPC#	Replacement Parts
60428	Replacement case for 60430/60431
60432	Lightweight 60430/60431 bar, inch
60433	Lightweight 60431 bar, metric
60434	Replacement yoke for 60430/60431
60435	6 mm swage pin for 60431
60436	8 mm swage pin for 60431
60471	10 mm swage pin for 60431
60437	12 mm swage pin for 60431
60438	16 mm swage pin for 60431
60451	18 mm swage pin for 60431
60452	Flaring cone for 60430/60431
60472	1/4" swage pin for 60430
60473	5/16" swage pin for 60430
60474	3/8" swage pin for 60430
60477	1/2" swage pin for 60430
60478	5/8" swage pin for 60430
60479	3/4" swage pin for 60430



## SWAGING AND 45° FLARING TOOL 3/4" to 1-1/8" O.D.



60455 large-size swages and flares for 3/4", 7/8" and 1-1/8" O.D. tubing

## SWAGING AND 45° FLARING TOOL 3/16" to 3/4" O.D.



This combination tool both flares and swages soft or annealed copper and similar materials.

- Six hardened and plated alloy steel adapters are interchangeable to convert sizes and functions
- Slip-on self-centering steel yoke has a feed screw with extra long handle

- Deeply knurled adapters
- Flaring bars are hardened and chrome plated for durability
- Kit comes complete with six swage adapters, flaring cone, two flaring bars, yoke and a deluxe case  **MADE IN THE USA**

UPC#	Description
60440	Swage/flare kit complete for 3/16" to 3/4" O.D.
60450	Case only
60451	Case insert only
60444	3/16" and 3/8" Adapter
60439	1/4" Adapter
60445	5/16" Adapter
60446	1/2" Swage adapter
60447	5/8" Swage adapter
60448	3/4" Swage adapter
60449	Flare cone for 3/8" to 3/4" - 45° adapter
60442	"C" clip and nut
60441	Handle/feed screw
60443	Complete yoke 60440/60453
60212	Flare bar for 3/16" to 5/8" O.D.
60232	Flare bar for 1/2" to 3/4" O.D.

UPC#	Description
60446	1/2" Swage adapter
60447	5/8" Swage adapter
60448	3/4" Swage adapter
60449	Flare cone 1/2" to 3/4"
60443	Complete yoke for 60440/60453
60232	Flare bar 1/2" to 3/4" O.D.
60448	3/4" Swage adapter
60455	Large swage/flare kit complete 3/4" to 1-1/8" O.D.
60457	7/8" Swage adapter
60458	1-1/8" Swage adapter
60459	Flare cone 3/4" to 1-1/8"
60456	Complete yoke for 60455
60292	Flare bar 3/4" to 1-1/8" O.D.
60441	Handle screw assembly
60442	"C" clip and nut

## FLARING/CUTTING KITS



A wide variety of heavy-duty tool kits for flaring 3/16" to 3/4" O. D.



UPC#	Description
60240	Full range 45° flaring kit for 3/16" to 3/4" O.D. with yoke, two bars, case, instructions
60230	45° Flaring tool only for 1/2" to 3/4" O.D.
60250	45° Flaring/cutting kit for 3/16" to 5/8" O.D. with 60210 flaring tool, 60101 cutter, case, instructions
60260	Full range 45° flaring/cutting kit for 3/16" to 3/4" O.D. same as 60240 with 60101 cutter, case, instructions

## ELECTRIC/MANUAL LIGHTWEIGHT FLARING TOOL



UPC#	Kit Swaging/Flaring Sizes
60241	Inches: 6 positions for 1/4, 5/16, 3/8, 1/2, 5/8 and 3/4" O.D. tube
60242	Metric: 6 positions for 6, 8, 10, 12, 16 and 18 MM O.D. tube
UPC#	Replacement Parts
60433	Lightweight 60431 bar, metric
60434	Replacement yoke for 60430/60431
60243	Replacement side handle for 60241/60242
60244	Replacement top handle for 60241/60242

For super fast flaring, remove the top handle and replace with an electric drill bit.

- For use with electric/power drill (with torque adjusted function only).
- Handle included for manual flaring.
- Side handle locks movement of the yoke assembly during flaring.
- The hardened, polished eccentric cone of with 45° flare produces a rolling action for uniform flare walls without galling in 1/4" to 3/4" O.D. tubing.
- Built-in clutch release to prevent over-torquing.

CHARGING SYSTEMS  
GAUGES  
RECOVERY MACHINES  
VACUUM PUMP SYSTEMS  
VACUUM AND CHARGING HOSES  
HOSE ADAPTERS, VALVES & PARTS  
WIRELESS AND ELECTRONIC INSTRUMENTS  
LEAK DETECTORS AND MONITORS  
HEATING INSTRUMENTS  
SYSTEM TOOLS

## TUBING EXPANDER/SWAGER For 5/16" to 1-5/8" O.D.



60407



With long handles for comfortable leverage, easily expand 5/16" to 1-1/8" O.D. soft copper and aluminum tubing in seconds. Select from nine expander heads to attach to the front of the handles.

- Precise swaging on the job
- Re-round deformed tubes and fittings
- Salvage shorts and scrap to make couplings
- Handles, tapered expanding pin, and other moving surfaces heat treated for durability
- Use on 0.063" wall soft copper and aluminum to 1-5/8" O.D. (anneal hard copper prior to use)
- Use on 0.047" wall soft steel to 7/8" O.D.
- Kit includes six expander heads; three optional sizes sold separately

### Sets in case

UPC#	Description
60407	Expander kit with handles; heads for 3/8", 1/2", 5/8", 3/4", 7/8", 1-1/8" tubing O.D.; deburring tool, carrying case, instructions
60412	Expander handles
60405	Nut and bolt
60410	Expander handle hinge bolt (9 mm)
60411	Blue case
60427	Steel roller
60429	Drive pin

### Expander heads

UPC#	Description	Maximum wall thickness	Swage depth	Segment stretch
60413*	5/16" Expander head	0.039"	0.24"	—
60414	3/8" Expander head	0.039"	0.35"	0.06"
60415	1/2" Expander head	0.047"	0.43"	0.06"
60416	5/8" Expander head	0.047"	0.57"	0.06"
60417	3/4" Expander head	0.047"	0.59"	0.06"
60418	7/8" Expander head	0.047"	0.71"	0.06"
60420	1-1/8" Expander head	0.063"	0.77"	0.90"
60422*	1-3/8" Expander head	0.063"	0.77"	0.90"
60424*	1-5/8" Expander head	0.063"	0.77"	0.90"

\* Optional sizes sold separately.

## HYDRAULIC TUBE EXPANDER KIT

- Hydraulic power
- Eliminates fittings



60493

## PUNCH-TYPE SWAGING TOOL



60475

- Expands one end of copper tubing for connecting same size tubes
- Heat-treated and plated alloy steel
- Made in the USA

### Swaging sets

UPC#	Description
60475	Set - 4 piece in pouch for 1/4", 3/8", 1/2" and 5/8"
60476	Set - 5 piece in pouch for 1/4", 5/16", 3/8", 1/2" and 5/8"
60461	Set with clamping bar and 6 punches 3/16" to 5/8"
60462	Clamping bar only



MADE IN THE USA

60460

### Single tools

UPC#	Description
60460	Multi-swage punch, 6 sizes 3/16" to 5/8"
60463	3/16" O.D. punch
60464	1/4" O.D. punch
60465	5/16" O.D. punch
60466	3/8" O.D. punch
60467	1/2" O.D. punch
60468	5/8" O.D. punch
60469	3/4" O.D. punch
60470	7/8" O.D. punch

- Lightweight and portable
- Easy one-hand operation

UPC#	Description
60493	Deluxe hydraulic expander kit: heads for 3/8", 1/2", 5/8", 3/4", 7/8", 1-1/8", 1-3/8" and 1-5/8" tubing O.D.; small cutter, tube reamer, carrying case and instructions
60495	Replacement expander pin 3/8" to 1-5/8"
60498	Replacement case
60499	Replacement grease tube
60413-24	Replacement expander heads (see above)

## RATCHET HAND TUBE BENDER



Easy one hand bending of 1/4" to 7/8" soft copper and soft aluminum. Hard copper must be annealed before bending.

- Quick change bending mandrels and shoes
- Trouble free ratchet mechanism
- Index marks to locate bends
- Complete tube bender kit includes all items required to bend 1/4", 5/16", 3/8", 1/2", 5/8", 3/4" and 7/8" tubing



60342 reverse bending mandrel sold separately or included in 60325 kit

UPC#	Bending radius	Description
60331	—	Complete kit
60325	—	60331 kit and 60342 bending mandrel kit
60326	1"	1/4" O.D. bending mandrel
60327	7/8"	5/16" O.D. bending mandrel
60332	1-3/16"	3/8" O.D. bending mandrel
60333	1-3/8"	1/2" O.D. bending mandrel
60334	1-15/16"	5/8" O.D. bending mandrel
60335	2-13/16"	3/4" O.D. bending mandrel
60336	3-3/8"	7/8" O.D. bending mandrel
60329	—	Crossbar assembly complete - 3/4" to 7/8"
60330	—	Crossbar assembly complete - 1/4" to 5/8"
60338	—	Plastic carrying case
60339	—	Ratchet body
60342	—	Reverse bending mandrel
UPC#	Replacement parts for 60331	
60101	Small cutter for 1/8" to 1-1/8" O.D.	
60161	Tube reamer for 1/16" to 1-3/8" O.D.	
60328	Lever screw (20)*	
60339	Ratchet body (10)*	
60340	Ratchet bar (9)* and catch bolt (14)*	
60344	Catch pin (13)* and spring (15)*	
60345	Catch lever (16)*	
60346	Flat spring (17)*	
60347	Feed lever (19)*	
60348	Wing nut screw (8, 11)*	
60349	Tension spring (18)*	

\* Designates the call-out number for the parts diagram on the 60331 instruction chart.

## FULL RANGE HEAVY DUTY TUBE BENDERS For 1/4" to 7/8" radius



Make fast bends on almost every size of soft copper, brass, aluminum, steel and soft stainless steel tubing to 180°.

60390 is a compact three-in-one bender for 1/4", 5/16" and 3/8" O.D. tubing. Calibrated markings for bends up to 180° help you duplicate angles.

UPC#	Bending radius	Description
60390	15/16"	1/4", 5/16", 3/8" 3-in-1 Tube bender
60373	9/16"	1/4" Tube bender
60374	11/16"	5/16" Tube bender
60375	15/16"	3/8" Tube bender
60377	1-1/2"	1/2" Tube bender
60378	2-1/4"	5/8" Tube bender
60379	3"	3/4" Tube bender
60380	3-1/4"	7/8" Tube bender

## SPRING TUBE BENDER For 1/4" to 7/8"



Spring benders slip over soft copper and aluminum tubing during bending to help prevent tube collapse.

- Silver-plated finish
- Conforms to Fed. Spec. GGG-B-191-a Type IV

UPC#	Description
60354	1/4" O.D. bending spring
60355	5/16" O.D. bending spring
60356	3/8" O.D. bending spring
60357	7/16" O.D. bending spring
60358	1/2" O.D. bending spring
60359	5/8" O.D. bending spring
60360	3/4" O.D. bending spring
60361	7/8" O.D. bending spring
60351	Set-6 sizes-1/4", 5/16", 3/8", 7/16", 1/2" and 5/8" O.D.
60352	Set-4 sizes-1/4", 3/8", 1/2" and 5/8" O.D.
60353	Set-4 sizes-1/2", 5/8", 3/4" and 7/8" O.D.



## DIGITAL ADJUSTABLE TORQUE WRENCH



### FEATURES & BENEFITS

- Adjustable spanner head
- Digital torque value readout
- +/- 2% accuracy
- CW and CCW operation
- Peak hold and track mode selectable
- Buzzer and LED indicator for the nine pre-set target torques
- Four user selectable units of measure (ft. lb., in. lb., N-m, kg-cm)
- 50 data memory for recall and joint torque auditing
- Auto sleep (after about five minutes idle)
- Water contact indicator



60632

3/8" Drive Ratchet Head

The YELLOW JACKET® Adjustable Digital Torque Wrench captures and displays torque measurement in real time mode, providing users with unprecedented levels of control and accuracy.

The YELLOW JACKET® Adjustable Digital Torque Wrench captures and displays torque measurement in real time mode, providing users with unprecedented levels of control and accuracy.

For convenience, the torque wrench has nine common preset torque values, which display on the digital screen as the flare nut is tightened. For added assurance, indicator lights increase as the torque value is approached.

The adjustable wrench head means you can leave your other wrenches at home, and the protective carrying case keeps it safe as you carry it from job site to job site.

### SPECIFICATIONS

Square Drive:	3/8 in.
Length:	10.6 in. (270 mm)
Maximum Torque:	62.7 ft. lb. (85 N-m) 752 in. lb. (867 kg-cm)
Torque Measuring Range:	3.1 - 62.7 ft. lb. (4.2 to 85 N-m) 37 - 752 in. lb. (43 - 867 kg-cm)
Guaranteed Accuracy Range:	12.5 - 62.7 ft. lb. (17 - 85 N-m) 150 - 752 in. lb. (173 - 867 kg-cm)
Accuracy:	CW: ±2%; CCW: ±3%
Data Memory Size:	50
Pre-Sets:	9
LED Indicators:	6 (1 red, 5 green)
Operation Mode:	Peak hold/track
Unit Selection:	ft. lb., in. lb., N-m, kg-cm
Gear Teeth:	52
Head Open Size:	.2 - 1.18 inches (5 - 30 mm)
End Fitting Size (w x h):	.35 in. x .47 in. (9 x 12 mm)
Axial Distance:	17.5mm
Battery Type:	2 X AAA (Non-Rechargeable)
Operating Temperature:	14°F ~ 140°F (-10°C ~ 60°C)
Storage Temperature:	4°F ~ 158°F (-20°C ~ 70°C)
Humidity:	Up to 90% non-condensing
Drop Test:	1 m
Vibration Test:	10G

UPC#	Description
60648	Adjustable Digital Torque Wrench
60632	3/8" Drive Ratchet Head
60647	Adjustable Wrench Head 5-30mm

# SOLENOID VALVE SERVICE MAGNET

Fits most common solenoid and 4-way reversing valves.



Solenoid Valve



4-Way Reversing Valve

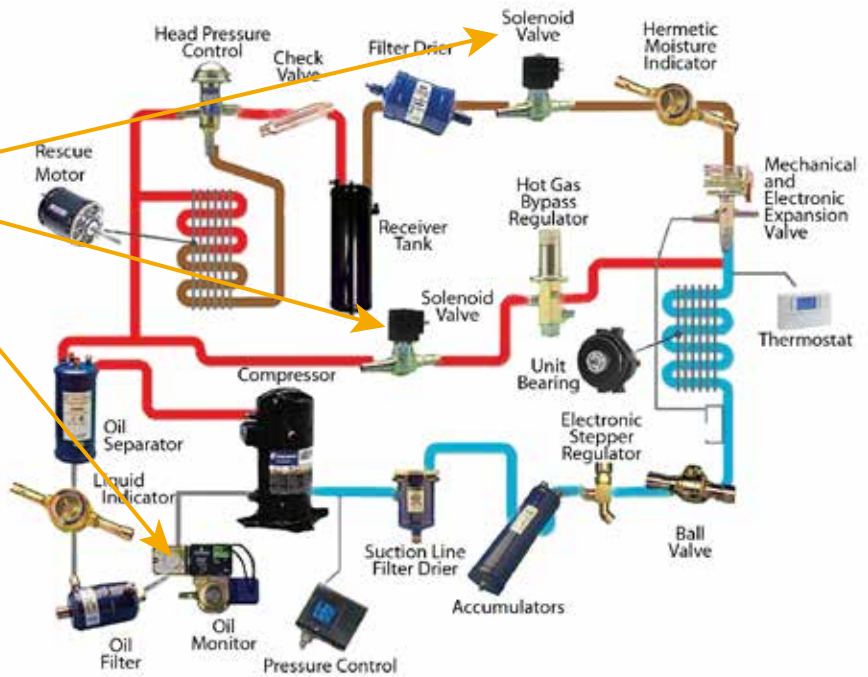

To optimize recovery, simply remove the solenoid coil from all normally closed valves – refrigerant control valves, hot gas defrost valves, reversing valves, etc. Then apply the **YELLOW JACKET®** solenoid magnet to each valve to speed up recovery and evacuation.

To help isolate solenoid valve issues, remove the coil from the valve and apply the **YELLOW JACKET®** solenoid magnet. If the valve actuates, an electrical or solenoid coil issue is indicated. If the valve actuates but there is no flow, this indicates a plugged valve. No actuation indicates the problem is in the valve body itself.



The **YELLOW JACKET®** Solenoid Valve Service Magnet is the quickest and easiest way to manually operate solenoid valves. It works by magnetically lifting the stem assembly and plunger to actuate the valve during service.

### Test and Control

Use this solenoid service magnet to test, troubleshoot, or manually activate and control a direct connected or pilot operated 2-way solenoid, 3-way reclaim or 4-way reversing valve, typically found in a reverse cycle air conditioner or heat pump.

### Recovery and Evacuation

This magnet can also be used to hold a solenoid valve open during recovery and evacuation so the entire system can be accessed.

### Other Uses

- Use in place of the power head on a hot water oil shutoff valve to eliminate the need to wait for the delay on open
- Use it to temporarily replace a faulty coil to open the solenoid valve
- Use it to turn the power on or replace the solenoid if it is bad

### Specifications

Opening:	0.75 in. (18 mm) fits most common manufactured valves including reversing valves.
Diameter:	1.5 in.
Length:	1.6 in.

UPC#	Description
61192	Solenoid Service Magnet

CHARGING SYSTEMS  
GAUGES  
RECOVERY MACHINES  
VACUUM PUMP SYSTEMS  
VACUUM AND CHARGING HOSES  
HOSE ADAPTERS, VALVES & PARTS  
WIRELESS AND ELECTRONIC INSTRUMENTS  
LEAK DETECTORS AND MONITORS  
HEATING INSTRUMENTS  
SYSTEM TOOLS

## MINI-SPLIT TOOL KIT



The YELLOW JACKET® Mini-Split Tool Kit addresses many of the special requirements found in mini-split installation manuals.

- R-410A service tools
- Takes the guesswork out of finding the right tool for the job
- Meet manufacturers' specifications on mini-split installations and repairs
- 60991 for domestic and 60992 for international service technicians

### Each kit includes:

- Heat Pump Manifold  
Designed to handle all mini-split refrigerants and pressures (including heating modes) (R-410A only on 60992)
- 60" PLUS II Hoses  
Rated for 400 psi (276 bar) minimum burst and 800 psi (55 bar) maximum working pressure.
  - 60991 - (RYB) 1/4" with 1/4" flare fittings
  - 60992 - 1/4" with 1/4" flare flare fittings (Y), 1/4" x 5/16" (R&B) and; (Red) 1/4" Female flare on manifold connection and 1/4" female flare on angled service end.
- Eccentric Cone Flare Tool  
Creates high quality flares for 3/16" to 3/4" O.D. tubing
- Hex Key Set  
Mini-Split Hex Keys - 5/32", 3/16", 5mm and 6mm
- Vacuum/Charge Valve with Side Port
  - 60991: 5/16"x1/4"x1/4" (18986)
  - 60992: 5/16"x5/16"x5/16" (18985)
- 45° R-410A Coupler 5/16" Female Quick Coupler x 1/4" Male Flare (60992 only)
- Tube Cutter and Deburring Tool
- Adjustable Torque Wrench
  - 60652 Eight head kit includes: 60991: 16, 17, 21, 22, 24, 26, 27 and 29 mm flare nuts
  - 60650 Six head kit includes: 60992: 17, 22, 24, 26, 27 and 29 mm flare nuts
- 16" Tool Bag  
Durable nylon bag with strap and over 25 pockets

UPC#	Description
60991	Mini-split tool kit with tool bag (R-22/407C/410A Heat pump manifold)
60992	Mini-split tool kit with tool bag (R-410A Heat pump manifold)
60990	16" tool bag

## PRECISION TORQUE WRENCH



Designed to accommodate the full range of ductless mini-split flare nut sizes and torque requirements.

Easier-to-use and more adjustable than other flare nut torque wrenches on the market.

Precision torque wrench for exact tightening to 10-80 N-M or 7.4-59 ft. lb.

- Adjustable in Newton-meters and foot-pound.
- Six interchangeable open end adapters.
  - 60650 (6 Heads): Sizes: 17, 22, 24, 26, 27 & 29 mm
  - 60652 (8 Heads): Sizes: 16, 17, 21, 22, 24, 26, 27 & 29 mm
- The N-M and foot-pound (FT-LB) scales are marked on the barrel of the wrench for easy and permanent reference.
- The micrometer-type sleeve is easy to read and allows accurate pre-set torque values to be set. When the set torque is reached, the wrench produces an audible click and a slight, safe release of tension to prevent over tightening.
- This product has been designed to be tough, durable and easy to use. It comes supplied in a blow-molded storage and carry case.
- Accurate within 4% when measured per BSEN 26789 & ISO 6789 & ASME B107.14M & DIN3122 regardless of the open end adapter head used.



The N-M and foot-pound (FT-LB) scales are marked on the barrel of the wrench for easy and permanent reference.

UPC#	Description
60650	Torque wrench kit - 6 heads
60652	Torque wrench kit - 8 heads



## SERVICE WRENCHES



60613

**Standard** reversible ratchet wrench with square openings: 1/4" and 3/16" at one end; 3/8" and 5/16" at other end.



60618

**Heavy-duty** features a heavier handle and larger gear. Stronger gear teeth are combined with strong reversing mechanism for long service life.

Square opening 3/16" and 1/4" at one end; 3/8" and 5/16" at other end.



60616

**Knuckle saver** design for convenience in tight areas. Square opening 1/4" and 3/16" one end; 3/8" and 5/16" at other.



60615

Reversible wrench for **larger service valves**. 3/8" square one end; 1/2" square at other.



60612

**7" heavy-duty** reversible ratchet wrench with hex openings 1/2" and 9/16" at one end; square 3/16" and 1/4" at other end.

### Service wrenches

UPC#	Description
60613	Straight service wrench
60618	Heavy-duty service wrench
60616	Off-set service wrench
60615	Refrigeration wrench for large valves
60612	7" Heavy-duty wrench
60003	60613 (50 pak)
60006	60616 (50 pak)
60008	60618 (42 pak)

CAUTION: Do not use cheater bars.

## SERVICE WRENCH AND ADAPTER

Combination service wrench and hex adapter for accessing liquid and suction based valves on residential and commercial units up to 7.5 tons. Heat-treated hex works for 3/16" and 5/16" hex valves. Black oxide plated. New adapter for some York and Coleman units.



UPC#	Description
60609	Hex key adapter
60610	60613 service wrench and 60609 adapter
60638	Shorter 3/16" and 5/16" hex key adapter

## KNUCKLE-SAVER™ HEX WRENCH SETS

### Three-piece or five-piece



The offset design saves knuckles in tight places.

- Accurately sized and broached ends for correct fit
- Heat-treated critical wear parts for long life
- Finger control reversing
- Chrome plated for durability
- Made in the USA 

UPC#	Description	Hex sizes
60630	Set - 5 wrenches	1/4" to 7/8"
60631	Set - 3 wrenches	1/4" to 9/16"
60633	Ratchet wrench	1/4" x 5/16"
60634	Ratchet wrench	3/8" x 7/16"
60635	Ratchet wrench	1/2" x 9/16"
60636	Ratchet wrench	5/8" x 11/16"
60637	Ratchet wrench	3/4" x 7/8"

## SPORLAN VALVE WRENCH



Spanner end tightens packing nut around super heat adjustment stem. 1/8" square end adjusts Sporlan solenoid valves with manual lift stems as on Series B6 and E6 through MA 50. Also 3/16" square at same end for expansion valves.

UPC#	Description
60617	Sporlan valve wrench



CHARGING SYSTEMS  
GAUGES  
RECOVERY MACHINES  
VACUUM PUMP SYSTEMS  
VACUUM AND CHARGING HOSES  
HOSE ADAPTERS, VALVES & PARTS  
WIRELESS AND ELECTRONIC INSTRUMENTS  
LEAK DETECTORS AND MONITORS  
HEATING INSTRUMENTS  
SYSTEM TOOLS

CHARGING SYSTEMS  
GAUGES  
RECOVERY MACHINES  
VACUUM PUMP SYSTEMS  
VACUUM AND CHARGING HOSES  
HOSE ADAPTERS, VALVES & PARTS  
WIRELESS AND ELECTRONIC INSTRUMENTS  
LEAK DETECTORS AND MONITORS  
HEATING INSTRUMENTS  
SYSTEM TOOLS

## TUBE DEBURRING TOOL

For fast deburring, rotate blade.



UPC#	Description
60163	Deburring tool with spare blades
60164	Replacement blade for 60163
60165	Economy deburr for 60139 tube cutter
60166	Economy deburr for 60146 tube cutter

## TUBE REAMER/BURR REMOVER

Steel blades remove inner and outer burrs.



UPC#	Description
60161	Tube reamer - 1/16" up to 1-3/8" O.D.

## PREMIUM TUBE CUTTERS



Retracted



Extended



Spare blade stored in handle

Enclosed precision feed mechanism for easy, smooth cutting.

- Wide rollers with flare cut-off groove for convenience. Ground surface for easy rolling
- Wheel retracts into cutter body to save 1" in cutting radius
- Textured finish is easy to grip and hold
- Alloy steel wheels have a sharper cutting wheel edge for less burr on copper, aluminum and mild steel tubing
- Wheels are pinned to rotate in either direction without the screw backing out
- Corrosion-resistant finish on lightweight aluminum frame



- Fold away steel reamer with turned cutting edge for deburring
- Flare cut-off groove for quickly removing damaged flare
- Small and large sizes available
- Conforms to Fed. Spec. GGG-C-771-d, 1-31, 64. Type II, Class 1.

## CONSTRICTOR/CUTTER

Cutter modified with blunt wheel to roll down the tube O.D.

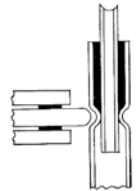

UPC#	Description
60101	Small cutter* for 1/8" to 1-1/8" O.D.
60102	Large cutter* for 1/4" to 1-5/8" O.D.
60103	Constrictor/cutter for 1/4" to 1-1/8" O.D.

Spare parts listed on page 104

## HEAVY DUTY MINI-CUTTERS



Mini-cutters are compact yet easy to grip and feature large rollers and flare cut-off groove.

**Mini-cutter 60121** for heavy-duty cutting from 1/4" to 7/8" O.D.

**Small Mini 60160** cuts 1/8" to 5/8" with a turning radius of only 1-3/16".

**Big Mini 60142** cuts from 1/4" to 1-1/8" O.D.

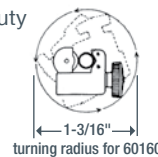

1-3/16" turning radius for 60160



UPC#	Description
60160	Small Mini for 1/8" to 5/8" O.D.
60121	Mini-cutter for 1/4" to 7/8" O.D.
60142	Big Mini for 1/4" to 1-1/8" O.D.

Spare parts listed on page 104

## LARGE TUBE CUTTERS To 5-1/8" O.D. (130 mm)

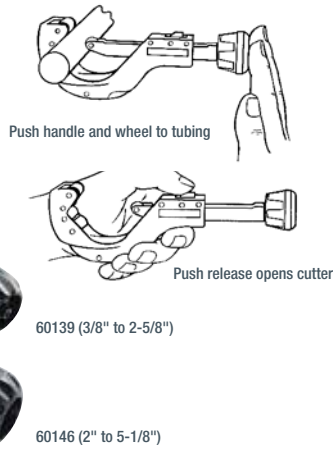

- "I beam" design uses aluminum alloy for both strength and light weight
- Wide body has long rollers to hold tubing and includes a flare cut-off groove
- Contoured handle for easy gripping also holds spare cutter wheel
- Separate deburr tool slides into cutter body

UPC#	Description
60139	Tube cutter for 3/8" to 2-5/8" O.D.
60146	Large tube cutter for 2" to 5-1/8" O.D.
60165	Replacement deburr tool for 60139
60166	Replacement deburr tool for 60146
60136	Individual/Retainer screw
60172	Handle screw for 60139
60173	Handle and screw for 60139
60174	Spring for 60139

## PIPE CUTTER For black iron



Cuts black iron pipe more cleanly and quickly than other types of cutters. Cast iron body holds heat-treated steel cutter wheel.

- Fine pitch threads assure easy cuts on black pipe
- Large rollers for clean right angle cuts

UPC#	Description
60131	6 lb. pipe cutter for 1/8" to 2" pipe
60132	Pipe cutter wheel for 60131

## PVC AND POLYETHYLENE PIPE CUTTER



- Easy ratchet action and unique hooked tube-gripping jaws give an easy and clean cut
- Steel alloy blade is replaceable, repairable and heat-treated for long life

UPC#	Description
60190	PVC pipe cutter up through 3/4"
60191	PVC pipe cutter up through 1-1/4"
60152	PVC pipe cutter up through 2-1/8"
60193	Replacement blade for 60190
60194	Replacement blade for 60191
60155	Replacement blade for 60152

## CAPILLARY CUTTER



Cleanly cut capillary tubing without flattening or constricting tubing.

UPC#	Description
60195	Capillary cutter



### TIPS FOR CUTTING

Cutters are designed for different applications and materials, and must be used properly for optimum performance.

- Tubing cutters are designed for softer thinner-wall materials such as copper, aluminum and brass. The wheel is designed very specifically with a sharp edge for quick cutting
- Black iron pipe cutters are larger in size and use fine pitch threads and large rollers for clean right-angle cuts

To ensure lasting tool performance, use the correct cutters for copper and pipe cutters for black iron pipe.



CHARGING SYSTEMS

GAUGES

RECOVERY MACHINES

VACUUM PUMP SYSTEMS

VACUUM AND CHARGING HOSES

HOSE ADAPTERS, VALVES & PARTS

WIRELESS AND ELECTRONIC INSTRUMENTS

LEAK DETECTORS AND MONITORS

HEATING INSTRUMENTS

SYSTEM TOOLS

Tube cutter parts – organized by cutter							
UPC#	Qty	Pkg*	UPC#	Qty	Pkg*	Description	Cutter
60098	1	B	60099	10	B	Cutter wheels for stainless	60101, 60102, 60103
60079	1	B	60097	5	B	Axel with detent	60101, 60102, 60103
60093	1	B	—	—	—	Package one each wheel, pin	60101, 60102, 60103
60100	1	B	60107	10	B	Cutter wheels for copper	60101, 60102, 60103, 60160
60106	1	B	60117	10	B	Constrictor wheels	60101, 60102, 60103
60077	1	B	60095	5	B	Reamer screw and washer	60101, 60102, 60103
60078	1	B	60096	5	B	Reamer	60101, 60102, 60103
60108	1	B	60129	5	B	Screw for knob	60101, 60102, 60103
60074	1	B	60075	5	B	Screw for cutter wheel	60121
60072	1	B	60073	10	B	Cutter wheels	60121
60080*	1	B	60125*	5	B	Screw for cutter wheel	60121, 60123
60120*	1	B	60116*	20	B	Cutter wheels	60121, 60142
60144	1	B	60143	5	B	Cutter blade pin and clip	60142
60124	1	B	60115	10	B	Cutter wheels	60139
60136	1	—	60140	5	—	Screw/retainer	60139
60172	1	B	—	—	—	Screw for handle	60139
60174	1	B	—	—	—	Spring for shaft	60139
60165	1	—	—	—	—	Replacement deburr tool	60139
60147	1	B	60148	5	B	Cutter wheels	60146
60141	1	B	60149	5	B	Screws for cutter wheels	60146
60166	1	—	—	—	—	Replacement deburr tool	60146
60110	1	B	60088	10	B	Cutter wheel	60122 and 60160
60081	1	B	60085	10	B	Screw	60122 and 60160
60110	1	B	60088	10	B	Spare cutting wheel	60122 and 60160
60081	1	B	60085	10	B	Spare screw	60160
60111	1	B	60089	10	B	Cutter wheel for Imperial	75015 174-F, 274-F, 312-FB, 374-FC, TC 1000, TC 1020, TC 2050
60112	1	B	60090	10	B	Cutter wheel for stainless Imperial	75046 174-F, 274-F, 312-FB, 374-FC, TC 1000, TC 1020, TC 2050
60082	1	B	60086	10	B	Screw for Imperial	74762 174-F, 274-F, 312-FB, 374-FC, TC 1000, TC 1020, TC 2050
60113	1	B	60091	10	B	Cutter wheel for Imperial	74761 206-FA
60083	1	B	60087	10	B	Screw and nut for Imperial	77511 206-FA

\* For old model with Ritchie imprint.

## SERVICE COUNTER KIT



Kit quantities only. Order individual parts and packs for restocking from chart.

Service counter cutter parts kit 60130			
UPC#	Qty	Description	Cutter
60130		Counter selection - tube cutter maintenance kit as below	
60179	1	Kit box only with label - empty	
60100	3	Cutter wheels for copper	60101
60079	3	Axel with detent	
60097	5	Axel with detent	
60077	3	Reamer screw and spacer	60102
60078	3	Reamer	60103
60106	3	Constrictor wheel	60121 (old)*, 60142
60098	3	Cutter wheel for stainless	
60108	3	Screw for knob	
60120	6	Cutter wheels	60121 (new)*
60072	3	Cutter wheels	60121 (old)*
60080	3	Cutter wheel screw and retainer	60121 (new)*
60074	3	Cutter wheel screw and retainer	60142
60144	3	Cutter pin and clip for wheel	60139
60124	3	Cutter wheels	60139
60136	3	Cutter wheel screw and retainer	60160
60110	3	Spare cutting wheel	60160
60081	3	Spare screw	60160

\* 60121 (old) model with Ritchie imprint.  
\* 60121 (new) model with YELLOW JACKET imprint.

## RETAINING RING PLIERS – COMBINATION INTERNAL/EXTERNAL

Compact pliers for use on SealRight™ coupler with interchangeable tips.



- Six point broached jaw for accurate tip alignment. Adjustable for hex tips
- High handle-to-jaw ratio for increased mechanical advantage
- Easy-to-use – just set lever to “internal” or “external”
- Adjustable stop for efficient internal ring installation and prevention of external ring damage
- Spring return for easy control
- Includes pouch with five pairs of alloy steel replaceable tips and hex wrench

**Works on internal and external retaining rings where bearings are used, where a shaft must be held in a bore, under the dashboard and more.**

UPC#	Description
60593	Small pliers for 1/4" - 1" (8 mm - 26 mm) internal rings; 1/8" - 1" (3 mm - 26 mm) external rings
60596	Replacement tip set for 60593: straight 0.023" (0.6 mm), 0.036" (0.9 mm), 0.047" (1.2 mm); 90° 0.036" (0.9 mm), 0.047" (1.2 mm)

## HEX KEYS

All hex keys from 1/20" to 5/16" are premium 8650 heat-treated steel alloy for rugged use.

- Chamfered square cut ends for easy socket insertion
- Corrosion-resistant finish
- Patented organizer case with identifying slots that lock keys in place when not in use
- Ball end keys ease tightening of fasteners where sockets are up to 30° off axis. Provides fast full socket engagement where regular hex keys cannot do the job

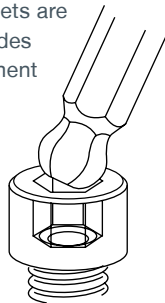

UPC# Standard End	Description	UPC# Ball End
60670	12 piece set with case	60685
60669	Metric – 12 piece set with case	—

## 12" HEX KEY WRENCHES

- Heat-treated for long life
- Chamfered ends for easy insertion into sockets
- Black finish



UPC# 25 per pkg.	Size		UPC# Individual
60750	Set 7 pcs. Hex key wrenches, includes all sizes below		
60757	5/64"	1-3/4"	60857
60758	3/32"	1-3/4"	60858
60760	1/8"	1-3/4"	60860
60762	5/32"	1-3/4"	60862
60763	3/16"	1-3/4"	60863
60764	7/32"	1-3/4"	60864
60765	1/4"	1-3/4"	60865

## FOLD-UP HEX KEY SETS



Locate the correct key size easily. For rugged use, each key is premium 8650 heat-treated steel alloy.

- Chamfered square cut ends for easy socket insertion
- Corrosion-resistant finish
- Smooth one-piece handle with sizes clearly marked
- Keys snap to work position for leverage and fold into handle for compact storage
- Replacement keys available

UPC#	Description
60700	Hex key set – 8 sizes - 1/20", 1/16", 5/64", 3/32", 7/64", 1/8", 9/64", 5/32"
60710	Hex key set – 9 sizes - 5/64", 3/32", 7/64", 1/8", 9/64", 5/32", 3/16", 7/32", 1/4"

CHARGING SYSTEMS  
 GAUGES  
 RECOVERY MACHINES  
 VACUUM PUMP SYSTEMS  
 VACUUM AND CHARGING HOSES  
 HOSE ADAPTERS, VALVES & PARTS  
 WIRELESS AND ELECTRONIC INSTRUMENTS  
 LEAK DETECTORS AND MONITORS  
 HEATING INSTRUMENTS  
 SYSTEM TOOLS

CHARGING SYSTEMS  
RECOVERY SYSTEMS  
MACHINES  
GAUGES  
VACUUM PUMP SYSTEMS  
VACUUM AND CHARGING HOSES  
HOSE ADAPTERS, VALVES & PARTS  
WIRELESS AND ELECTRONIC INSTRUMENTS  
LEAK DETECTORS AND MONITORS  
HEATING INSTRUMENTS  
SYSTEM TOOLS

## FAN BLADE PULLER



All steel design includes a 15/16" hex head and 5/8" shaft milled back 1-1/2" and undersized for 1/2" shaft opening. A self centering alignment tool is included.

Four fingers attach to the fan blade. For durability they are made of hardened 4140 chrome moly steel.

- Remove squirrel cage type blower wheels
- Pull off fan blades
- Remove pulleys or sheaves
- Fits 1-3/4" hub maximum (will work on a 10" pully if the diameter is less than 1-3/4")

Comes with 8 screws, 4 for hex key and 4 for wrench.

UPC#	Description
60590	Fan blade puller complete
60591	Replacement "fingers" (4)
60592	Bolt for 60590

## REFRIGERANT RECOVERY PLIERS



The fastest and easiest way to evacuate refrigerant before disposal of a unit.

- Snaps onto refrigerant line and punctures large hole for immediate and maximum full flow to recovery unit
- One adjustable tool fits all sizes from 3/16" to 7/8" O. D. hard tubing
- Replaceable hardened steel needle

UPC#	Description
60667	Refrigerant recovery pliers
60668	Replacement needle and gasket
19022	Replacement gasket only (5 pak)

## PINCH-OFF TOOLS

60665 will pinch off and reround 1/4", 5/16", 3/8" and 1/2" copper.

60661 pinches off copper and other lines quickly. Trigger release.

60666 is a ViseGrip® pinch-off tool.



UPC#	Description
60665	Bar-style pinch-off and reround tool
60661	Plier type pinch-off tool
60666	ViseGrip® pinch-off tool



## MAX-FLOW™ COMBINATION OIL PUMP

Pump oil into the compressor *on the down stroke* while the system is under pressure, making pumping easier with a positive stroke.

- Remove oil for recovery and conversion
- Add oil to existing systems
- Pumps 2.6 oz. or 78 ml per stroke
- Pumps against 200 psi pressure
- Comfort-grip rubber handle
- Universal stopper automatically adjusts to all standard openings in 1, 2-1/2 and 5 gallon oil containers
- Suction transfer hose and fittings included. Connects to bottom of unit to pump oil from equipment quickly and efficiently
- Use with alkyl-benzene, ester-based, polyol ester, mineral and synthetic oils
- Made in the USA 



UPC#	Description
77940	Max-Flow combination oil pump with tubing
77941	Automatic stopper for oil container openings for new 77940 pump
77942	"O" ring kit for 77940
77920	Adapter fitting straight – 1/8" NPT Male x 1/4" flare
77921	Adapter fitting 90° angle – 1/8" NPT Male x 1/4" flare
77922	24" suction hose – 1/4" fitting one end only

Note: Not for use with ammonia laden oil.

## MAX-FLOW™ DELUXE OIL PUMP

The Max-Flow deluxe oil pump is a high capacity unit for quick charging.

- Remove oil for recovery and conversion
- Add oil to existing systems
- Pumps 3.8 oz. (112.38 ml) per stroke
- Fits all size oil containers
- Foot stand base provides support and leverage while pumping against the high pressures of a running compressor
- Operating unit in reverse with adapter hose accessory removes oil from equipment quickly and efficiently
- Use with alkyl-benzene, ester-based, polyol ester, mineral and synthetic oils
- Will pump against 250 psi pressure
- Made in the USA 



UPC#	Description
77930	Max-Flow deluxe oil pump
77925	Plastic seat
77931	"O" ring kit for 77930
77932	Piston rod assembly
77935	Ball spring – 2 each
77936	Replacement suction copper tube with 1/2" flare nut at one end
77933	Replacement fittings – 3/8" NPT Male x 1/2" flare – 90°
77937	Replacement fittings – 3/8" NPT Male x 3/8" flare – 90°
77938	Optional 1/2" flexible suction hose, 24" long – fitting one end only
77939	Optional 3/8" flexible drain hose, 24" long – fitting one end only
59653	1/2" copper gasket soft (10 pak)

## REFILLABLE OIL INJECTORS

Add liquid to systems and sample refrigerant quickly and easily.

- Body and cap are rugged aluminum with "O" ring seal
- Male fitting at one end with Schrader. A ball valve for control on other end with a short length of hose
- Valve depressor in Female end
- 600 psi maximum working pressure
- Made in the USA 

UPC#	Description
69560	1/2 oz. Oil injector 1/4" Male flare x 1/4" Female Q.C.
69561	2 oz. Oil injector 1/4" Male flare x 1/4" Female Q.C.
69562	4 oz. Oil injector 1/4" Male flare x 1/4" Female Q.C.
69563	"O" ring 1/2 oz. injector (5 pak)
69564	"O" ring 2 and 4 oz. injector (5 pak)
69565	1/2 oz. R-134a auto injector with hose and service coupler
69566	2 oz. R-134a auto injector with hose and service coupler
69567	4 oz. R-134a auto injector with hose and service coupler
69722	Replacement hose for 69560, 69561 and 69562
69724	Replacement hose for 69565, 69566 and 69567



CHARGING SYSTEMS  
 GAUGES  
 RECOVERY MACHINES  
 VACUUM PUMP SYSTEMS  
 VACUUM AND CHARGING HOSES  
 HOSE ADAPTERS, VALVES & PARTS  
 WIRELESS AND ELECTRONIC INSTRUMENTS  
 LEAK DETECTORS AND MONITORS  
 HEATING INSTRUMENTS  
 SYSTEM TOOLS

CHARGING SYSTEMS  
GAUGES  
RECOVERY MACHINES  
VACUUM PUMP SYSTEMS  
VACUUM AND CHARGING HOSES  
HOSE ADAPTERS, VALVES & PARTS  
WIRELESS AND ELECTRONIC INSTRUMENTS  
LEAK DETECTORS AND MONITORS  
HEATING INSTRUMENTS  
SYSTEM TOOLS

## ERGONOMIC FINFIX™ COMBS

### For 14 different fin sizes

Color-coded nylon fin combs are designed to easily straighten and clean fins on standard and high efficiency condensers and evaporators. Shape conforms to the hand and thumb for a more comfortable grip.

Available individually bagged or as a set of six assorted. One set of six covers 12 different fin sizes. 61157 is for high efficiency units. 



Individual UPC#	Description	Fins per inch	Color	Bag of 25 UPC#
61151	FinFix 1	8 and 10	Orange	61161
61152	FinFix 2	9 and 15	Yellow	61162
61153	FinFix 3	11 and 13	Blue	61163
61154	FinFix 4	12 and 14	Green	61164
61155	FinFix 5	16 and 17	Lime	61165
61156	FinFix 6	18 and 20	Red	61166
61157	FinFix 7	21/22 and 23/24	Purple	61167
61158	Set of 6	8 to 20	Assorted	—

## 6-IN-1 FIN STRAIGHTENER

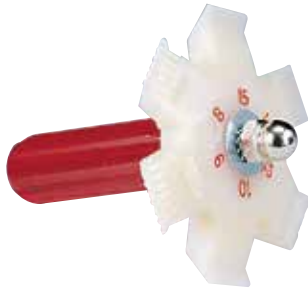

Fin straightener sizes are marked on the head - 8, 9, 10, 12, 14 and 15 fins per inch. Compact 4" length.

UPC#	Description
61171	6-in-1 Fin straightener
61172	Head only
61173	Handle only

## SAFETY GOGGLES



Helps protect your eyes against metal particles, sparks, refrigerant gases, etc. when working on HVAC/R systems.

Safety goggles are recommended any time you work on a system.

UPC#	Description
11002	Safety goggles
11003	Ventilated safety goggles

## STAINLESS TELESCOPING INSPECTION MIRRORS



- Check leaks in hard to see places
- Stainless steel mirror on ball joint rotates 360°
- Handle extends to 28"

UPC#	Description
78100	Round 3-3/4" diameter
78101	Rectangular 3-3/4" x 2"
78102	Rectangular 2" x 1-1/4"

## FIN STRAIGHTENERS

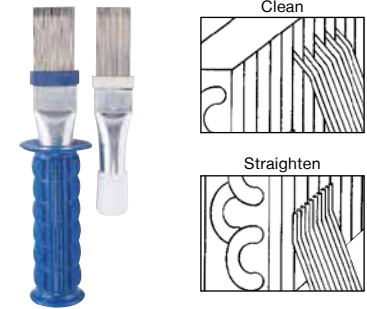

Fin straighteners straighten even severely damaged condenser and evaporator fins quickly and easily. Also clean away lint, rust, dirt and other debris.

Straightening wire tension is adjustable to accommodate various fin types. Wires are held by a sturdy metal body.

61170 includes a long comfort-grip handle, making straightener easier to use. Head is 20 percent wider than the 61150 to straighten more fins in one pass.

UPC#	Description
61150	Fin straightener
61170	Fin straightener with large handle

## TELESCOPING GLASS MIRRORS



UPC#	Description	Extension
78094	2-1/4" round	9-1/4" to 14-1/4"
78097	2-1/4" round magnified (2X)	9-1/4" to 14-1/4"

With pocket clip and insulated head		
78098	1-1/4" round	7" to 19"
78099	1-1/4" round magnified (2X)	7" to 19"
78103	2" x 3-1/2" rectangular	11" to 15-1/2"
78104	1" x 2" oval	7" to 19"

Replacement mirrors only	
78105	2-1/4" round glass
78106	2" x 3-1/2" rectangular glass
78107	1" x 2" oval glass

# PRODUCT INDEX

UPC #	Page #	UPC #	Page #	UPC #	Page #	UPC #	Page #	UPC #	Page #
11002-11003	108	19082-19088	64	21985	8	40318	26, 66	41151	23
10146	8, 12	19095	53, 63	21990	8	40319-40320	26	41202-41299	22
12036-14072	56	19096	45, 63	22012-25399	52	40325	66	41209	23
14536-14699	54	19100-19104	65	25602	53	40326	26, 66	41300-41305	67
14579	16, 61	19105-19106	64	25636-25799	52	40331-40342	26	41311-41315	22
14811-14821	26	19109	65	25802	53	40338-40340	66	41317-41318	67
15012-15496	54	19110	26,47, 65, 77	25836-25975	54	40344-40345	26	41319	22
15636-16696	55	19111-19120	65	25980	53	40350	66	41327-41328	67
16801-16912	58	19120-19122	65	25983-25988	52	40819	48, 76	41332	22
17803-17875	56	19121	13, 65, 73	25999	54	40822	26	41337-41338	67
18001	58, 64, 66	19122-19129	65	26002	53	40844	8	41339	19
18072	58	19130	48, 64	26036-26199	55	40860, 40870	7, 8	41353-41392	22
18136-18299	54	19131	45, 48, 64	26202	53	40875, 40877	7, 8	41441-41442	67
18160	8, 12	19132	48, 64	26236-26399	54	40922	17	41622-41632	23
18372	58	19133	45, 48, 64	27002	53	40944	22	41652	22-23
18412-18550	56	19142	67	27101-27710	56	41041-41044	18-19, 26	41659	23
18612-18912	58	19143-19148	64	27836-28599	54	41045-41047	18, 21	41702-41715	22
18971	45, 63	19153-19157	67	29001-29006	53	41048	21, 26	41780	22
18973-18974	63	19158	65, 67	29011	53	41061	26	41781	22
18975	45, 63, 88	19160	48, 64	29036-29048	52	41063	18, 19	41842-42007	23
18978-18981	63, 88	19161-19169	65, 67	29060-29072	52	41081, 41082	18	42021-42034	23
18981	45, 63	19171-19172	65	29096-29199	52	41087	21	42041-42044	25
18983-18984	63	19173	63, 65	29201-29206	53	41090	26	42051	22, 25
18985	45, 63	19174-19220	65	29211	53	41091-41094	21, 26	42052	25
18986	45, 63	19221	65, 73	29236-29399	52	41095	26	42054	22, 25
18987-18989	63	19222	65	29403-29486	53	41096	21, 26	42055	25
18990-18996	64	19236-19296	55	29425, 29465	8, 12	41099	26	42201	23
18997	63, 64, 88	19301	66	29595	52	41103	21, 26	42205	23
19000	64	19302	13, 14	29601-29606	53	41105	26	42215-44319	22
19003-19005	66		51-56, 66, 73, 74	29611	53	41106	21, 26	45922-45923	16, 61
19010	56, 66	19304	66	29636-29799	52	41113	18, 19, 21	45925	15, 61
19011	45, 48, 53, 54 55, 58, 63, 66	19305 14, 63-64, 73-74 19306	64	29836-29975	54	41116	21	46000-46174	20
19012	56, 66	19310-19350	55	29980	53	41118	26	46060-46062	24
19015	45, 48, 55 63, 66	19636-19999	55	29985	8, 12	41119-41122	26, 64	46176	20
19020	51-56, 58 63, 65-66, 73,74	20036-20199	54	29983-29988	52	41123-41124	26, 67	46180-46190	20
19021	66	20236-20399	55	29993-29996	53	41130	21	49001-49002	30
19022	66	20436-20599	54	29999	54	41131	18-19, 21, 23	49010	17, 21, 30-32
19026	66	20636-20750	55	36018-36019	48, 64	41132	26, 67	49013-49016	30
19030	45, 48	20812-20950	56	38081-38087	38	41133-41135	18, 21, 26	49017	24
19034	66	21012-21024	51	40190-40199	23	41138	26, 67	49027-49036	30
19037	52, 65, 66	21036	51	40201-40202	32	41139	18, 21, 45	49039-49040	31
19038-19041	52, 65	21048	51	40263	26	41140	18	49051-49064	30
19045	65	21060-21072	51	40265	21, 67	41141	21, 26	49067	31
19047-19048	66	21096-21399	51	40270-40271	18-19, 21	41142	18-19, 21, 23, 26	49090-49092	17, 31
		21403-21586	53	40272	45	41143	21	49100	17, 18, 21, 29
		21612-21988	51	40279	18-19, 21	41145	38	49103-49132	29
				40315-40317	66	41147-41153	21	49133-49134	29

CHARGING SYSTEMS  
GAUGES  
RECOVERY MACHINES  
VACUUM PUMP SYSTEMS  
VACUUM AND CHARGING HOSES  
HOSE ADAPTERS, VALVES & PARTS  
WIRELESS AND ELECTRONIC INSTRUMENTS  
LEAK DETECTORS AND MONITORS  
HEATING INSTRUMENTS  
SYSTEM TOOLS



# PRODUCT INDEX

UPC #	Page #	UPC #	Page #	UPC #	Page #	UPC #	Page #	UPC #	Page #
49137-49140	29	60152-60155	103	60647, 60748	98	69107	78, 88	78056-78057	32, 90
49141-49142	25, 29	60160	102, 104	60650-60652	100	69110	78	78059-78060	90
49145-49182	29	60161	97, 102	60661-60666	106	69215	79	78061	32, 90
49190	17, 21, 31	60163-60164	102	60667	106	69217-69218	79	78062-78065	90
49193-49194	16, 19	60165-60166	102-104	60668	106	69220-69222	79	78066	32
	30, 61	60172	103, 104	60669-60864	105	69228	78	78070-78075	88
49203-49270	29, 31	60173	103	60990-60992	100	69239	79	78076-78091	90
49271-49272	23	60174	103, 104	61150-61173	108	69250-69265	78	78094	108
49281	17	60178	66	61192	99	69320-69321	82	78095-78096	90
49283	15	60179	104	67001-67003	13, 14	69336-69338	83	78097-78107	108
49291	20	60190-60195	103		73, 74	69341-69343	84	78112	58
49421-49424	90	60210	94	67010	8, 14, 74	69354-69361	83	78612-79172	59
49511-49522	30	60212	94, 95	67012	13, 14, 73, 74	69371-69373	87	79472	61
49601-49604	29	60213	94	67013	14, 74	69375	83	79510	61
49801-49847	17	60214	93, 94	67014	13, 14	69379	87	80200-80240	44
49849	17, 56	60230-60232	94, 95		73, 74	69383-69386	83	81636-86836	60
49856-49864	17	60233	94	67020, 67021, 67023	13	69387	83, 87	93058	48
49865-49866	17	60240-60260	95	67020-67030	73	69388	83	93211	45
49867-49889	17	60268-60269	93	67030	8, 12, 13	69522	89	93265, 93266	43
49900-49964	15	60270-60272	94	67060	9-12	69555-69559	85	93387-93389	43
49965-49966	15	60273-60274	93	67061	8-12	69560-69564	85, 107	93394	13, 14, 73, 74
49967-49971	15	60275-60277	94	67062-67063	9-12	69565-69567	107	93530, 93533	44
49971	25	60278	93	67070, 67071	11, 12	69620-69623	86	93542-93591	41
49972	15	60290	94	68086-68099	76	69670	64	93592, 93593	41
49973-49997	15	60292	94, 95	68800-68835	72	69696-69699	87	93610, 93620	42
59511	88	60293	94	68848-68849	38	69700-69706	85	93825-93840	63
59651-59652	66	60295	93	68862	71	69708-69713	86	93842-93843	53, 63
59653	66, 107	60325-60390	97	68864	70	69721	85	93844	63
59654	66	60405-60429	96	68915-68916	79	69722	85, 107	93846	63
59655	56, 66	60428	94	68940-68979	78	69723	85	93847	45
60003-60008	101	60430-60431	94	69008	89	69724	85, 107	93848	63
60072-60100	104	60432	94	69010-69015	88	69727-69732	85	93850-93886	45
60101	97, 102, 104	60433-60434	94, 95	69020, 69021	46, 75	69733-69735	87	93887, 93889	43
60102	102, 104	60435-60438	94	69030	13, 46, 48	69782-69794	84	95002-95343	38
60103	102, 104	60439-60450	95		73, 75, 76	69803	86	95444-95448	38
60106-60120	104	60451	94, 95	69044-69045	32, 48	74761-77511	104	95449-95538	38
60121	102, 104	60452	94	69058-69080	47, 77	77920	107	95560	35
60122-60130	104	60455-60459	95	69081	47, 77	77921	45, 107	95730-95738	35
60131-60132	103	60460-60470	96	69086	48, 76	77922-77942	107	95760-95765	36
60135	66	60471-60474	94	69087	48, 76	77950	85		
60136-60139	103, 104	60475-60476	96	69088	48, 76	78011	89		
60140-60141	104	60477-60479	94	69089	72, 88	78012	58, 89		
60142	102, 104	60493-60499	96	69091	48, 76	78020-78032	89		
60143-60144	104	60590-60592	106	69092-69093	48	78041-78044	58		
60146	103, 104	60593-60596	105	69095	47, 77	78052	88		
60147-60149	104	60609-60638	101	69101	48, 76	78055	90		
				69103-69106	88				

# MANUFACTURERS REPRESENTATIVES USA

## Kivlan Group

100 Sterling Parkway, Ste. 111  
Mechanicsburg, PA 17050  
PH: 717-249-6019 | FAX: 717-960-1528  
info@kivlangroup.com  
www.kivlangroup.com

## Monti and Associates, Inc.

P.O. Box 866  
Arlington Heights, IL 60006  
PH: 847-956-8200 | FAX: 847-956-8237  
ma-line@ma-line.com  
www.ma-line.com

## Pacific Product Sales, Inc.

6100 219th Street SW, Ste. 480  
Mountlake Terrace, WA 98043  
PH: 425-392-6148 | FAX: 425-437-0480  
info@salespps.com  
www.pacificproductsales.com

## Morley Associates, Inc.

146 Cedar Street  
Branford, CT 06405  
PH: 877-466-7539 | FAX: 203-488-9790  
info@morleyassociates.com  
www.morleyassociates.com

## Pinnacle Product Sales, Inc.

11365 Clove Way  
Parker, CO 80134  
PH: 303-292-3032 | FAX: 303-484-5626  
info@salespps.com  
www.pinnacleproductsales.com

## E.V. Dunbar Company

4255 Wade Green Road, Ste 111  
Kennesaw, GA 30144  
PH: 770-218-1750 | FAX: 770-218-1756  
info@evdunbarco.com  
www.evdunbarco.com

## The Partners Group HVAC

PO Box 23  
Rowlett, TX 75030-0023  
PH: 877-314-2938 | FAX: 800-231-4617  
info@tpghvac.com  
www.tpghvac.com

## DENCO Manufacturers Representatives

1015 W. Foothill Blvd.  
Azusa, CA 91702  
PH: 626-815-9444 | FAX: 626-815-9894  
dave@dencorep.net  
www.dencorep.net

## Danko Mechanical Sales Company, LLC

625 W. Deer Valley Rd. #103-421  
Phoenix, AZ 85027  
PH: 602-298-9360  
danko@dankomsc.com  
www.dankomsc.com

## CANADA

### B.J. Williams & Associates, Inc.

745 Development Drive, Unit 3  
Kingston, ON K7M 4W6  
CANADA  
PH: 613-389-2879 | FAX: 613-389-4967  
shane@actoolsource.com  
www.actoolsource.com

## MEXICO, CENTRAL AND SOUTH AMERICA

### International Sales & Marketing Group, Inc.

1040 N 88 Avenue  
Plantation, FL 33322  
PH: 001-954-515-9445  
martin@internationalsalesgroup.net  
www.internationalsalesgroup.net

## INTERNATIONAL

### Fairfield Technologies Ltd.

Fairfield House  
St. Martins  
Guildtown Perthshire PH2 6AE  
UNITED KINGDOM  
PH: 00 44 (0) 1738 550 005  
info@fairfieldtechnologies.co.uk  
www.fairfieldtechnologies.co.uk

## AUSTRALIA

### Sky Refrigeration Pty Ltd.

54 Industrial Park Drive  
Lillydale VIC 3140  
AUSTRALIA  
PH: +61 3 9735 2313  
pete@skyrefrig.com

## CONTACT THE FACTORY

### Ritchie Engineering Co., Inc.

custserv@yellowjacket.com  
www.yellowjacket.com  
10950 Hampshire Avenue South  
Bloomington, MN 55438  
PH: 952-943-1300 | FAX: 952-943-1605

### EUROPEAN DISTRIBUTION CENTER

Riverview Business Park, Unit 10  
Friarion Road  
Perth PH2 8DF  
PH: 00 44 (0) 1738 459 020

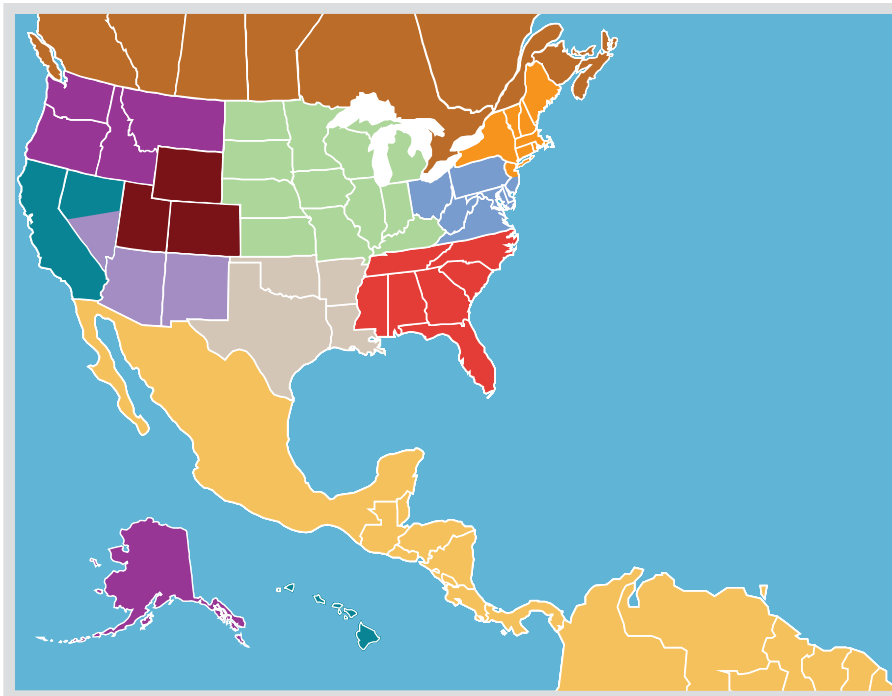

CHARGING SYSTEMS  
GAUGES  
RECOVERY MACHINES  
VACUUM PUMP SYSTEMS  
VACUUM AND CHARGING HOSES  
HOSE ADAPTERS, VALVES & PARTS  
WIRELESS AND ELECTRONIC INSTRUMENTS  
LEAK DETECTORS AND MONITORS  
HEATING INSTRUMENTS  
SYSTEM TOOLS



# ***70 YEARS OF EXPERTISE BUILT INTO EVERY TOOL***

## **YELLOW JACKET® CORPORATE OFFICE**

**ADDRESS:**

**10950 Hampshire Avenue South  
Bloomington, MN 55438 U.S.A.**

**PHONE:**

**800.769.8370  
952.943.1333**

**FAX:**

**800.322.8684  
952.943.1605**

**YELLOWJACKET.COM**

**EDITION 70**

**©1/20 Ritchie Engineering Co. Inc.  
P/N 10003**

